



***YOUR WORLD*** **OUR TOOLS**

**GSA RANGE CATALOGUE**

**2026**





2

TOOL ASSORTMENTS



12

SPANNERS



26

SOCKET SETS



36

SCREWDRIVERS



54

VDE INSULATED TOOLS



70

LIGHTING

**R9320 0023**

**SAFETY KNIFE**

















**R9570 0176**

**CLAMP LAMP  
1700**



**CONTENTS**

	<b>TOOL ASSORTMENTS</b>	<b>2 – 9</b>		<b>MEASURING</b>	<b>48 – 49</b>
	<b>MOBILE TOOL STORAGE</b>	<b>10 – 11</b>		<b>CUTTING / FILING</b>	<b>50 – 53</b>
	<b>SPANNERS</b>	<b>12 – 15</b>		<b>1000 V</b>	<b>54 – 57</b>
	<b>RANGE OF SOCKETS</b>	<b>16 – 25</b>		<b>AUTOMOTIVE</b>	<b>58 – 69</b>
	<b>SOCKET SETS</b>	<b>26 – 33</b>		<b>LIGHTING</b>	<b>70 – 73</b>
	<b>TORQUE WRENCHES</b>	<b>34 – 35</b>		<b>MERCHANDISING</b>	<b>74 – 77</b>
	<b>SCREWDRIVERS AND BITS</b>	<b>36 – 39</b>		<b>ARTICLE INDEX</b>	<b>78 – 80</b>
	<b>PLIERS</b>	<b>40 – 45</b>			
	<b>STRIKING TOOLS</b>	<b>46 – 47</b>			

# TOOL ASSORTMENTS

FULLY  
EQUIPPED



## COMBINABLE ALL-ROUND CAREFREE PACKAGES

- Assortments and modules can be combined with GEDORE red tool storage
- The perfect equipment for different areas of application, ready to use

**R21600060**  
TOOL ASSORTMENT

62 pieces



- > All tools are packed in plastic inserts
- > Stored in a rigid sheetmetal toolbox



**R21600065**  
UNIVERSAL TOOL ASSORTMENT

65 pieces



- > All tools are packed in plastic inserts
- > Stored in a rigid sheetmetal toolbox



Code	No.	Contents	Contents	Pieces	Weight
<b>3365000</b>	R21020060 (Tools only)	<b>1/2" Bi-Hex</b>	R20660067 Toolbox	61	6.200
<b>3365004</b>	R21600060 (In toolbox)	<b>Socket:</b> 8 10 11 12 13 14 15 16 17 18 19 21 22 24 26 27 28 30 32	R36605009 Allen key set 1.5 2 2.5 3 4 5 6 8 10 R60000027 Reversible ratchet R65100014 Extension 75mm R65100024 Extension 125mm R65100049 Extension 250mm R28302200 Combination pliers R28502200 Telephone pliers R28100010 Water pump pliers R38002006 Screwdriver set ⊖ 3 5.5 6.5mm ⊕ PH0 PH1 PH2 R65200049 Sliding T-bar R28422180 Side cutters R27200010 Curved jaw locking pliers	62	17.000

Code	No.	Contents	Contents	Pieces	Weight
<b>3365001</b>	R21020065 (Tools only)	<b>1/2" Bi-Hex</b>	R20660067 Toolbox R92160004 Hammer	64	6.200
<b>3365005</b>	R21600065 (In toolbox)	<b>Socket:</b> 8 10 11 12 13 14 15 16 17 18 19 21 22 24 26 27 28 30 32	R36605009 Allen key set 1.5 2 2.5 3 4 5 6 8 10 R60000027 Reversible ratchet R65100014 Extension 75mm R65100024 Extension 125mm R65100049 Extension 250mm R65300012 Universal joint R28302200 Combination pliers R28502200 Telephone pliers R28100010 Water pump pliers R38002006 Screwdriver set ⊖ 3 5.5 6.5mm ⊕ PH0 PH1 PH2 R94550005 Tape measure R65200049 Sliding T-bar R28422180 Side cutters R27200010 Curved jaw locking pliers	65	18.000

**NEW**

# R2143 0114 TOOL ASSORTMENT

114 pieces

High-density foam  
inserts



Rigid sheetmetal  
toolbox



Code	No.	Pieces	Weight Kg
3365008-D	R21430114	114	18.100

**13 Piece-1/4 DR. 6PT Sockets:**

4, 4.5, 5, 5.5, 6, 7, 8, 9, 10, 11, 12, 13, 14mm

**19 Piece-1/2. 6PT Sockets:**

10, 11, 12, 13, 14, 15, 16, 17, 18, 19, 20, 21, 22, 23, 24, 27, 28, 30, 32mm

**4 Piece-1/2, 6PT Deep Sockets:**

14, 15, 17, 19mm

1 Piece-1/4, Quick-Release Ratchet

1 Piece-1/4 Universal Joint

2 Piece-1/4 50 & 100mm Extension

1 Piece-1/4 Sliding T-Bar.

1 Piece-1/4 6-1/2 Spinner Handle with Extension.

1 Piece-1/2 Quick-Release Ratchet Handle

2 Piece-1/2 Spark Plug Socket 16 21mm

1 Piece-1/2 Universal Joint

1 Piece-1/2 Coupler Adaptor

3 Piece-Hex Key Wrenches: 1.5, 2, 2.5mm

8 Piece-1/4 6PT Deep Sockets: 6, 7, 8, 9, 10, 11, 12, 13mm

2 Piece-Extension Bar 1/2: 125, 250mm

1 Piece-3/8 T-Bar Adaptor.

1 Piece-250mm Water Pump Pliers.

1 Piece-Linesman Pliers.

18 Piece-1/4. Bit Sockets:

4 Piece-HEX: 3, 4, 5, 6mm

3 Piece-SLOTTED: 4, 5.5, 6.5mm

2 Piece-PHILLIPS: PH1, PH2

2 Piece-POZI: PZ1, PZ2

7 Piece-STAR: T8, T10, T15, T20, T25, T27, T30

15 Piece-5/16 BITS:

4 Piece-HEX: 8, 10, 12, 14mm

3 Piece-SLOTTED: 8, 10, 12mm

2 Piece-PHILLIPS: PH3, PH4

2 Piece-POZI : PZ3, PZ4

4 Piece-STAR: T40, T45, T50, T55

1 Piece-1/2 Drive 5/16 Coupler Adaptor

17PC-Combination Spanners: 6, 7, 8, 9, 10, 11, 12, 13, 14,

15, 16, 17, 18, 19, 20, 21, 22mm

Tape Measure-3m



## R2143 0113 TOOL ASSORTMENT

113 pieces



- > Lockable.
- > Three easy-slide drawers, incorporating full extension ball bearing slide mechanisms.
- > Retractable spring-loaded handles.
- > Four-compartment rigid sheetmetal tool chest.
- > Central drawer locking mechanism.
- > Plastic inserts.
- > Dimensions: 520 x 310 x 230mm.



Code	No.	Pieces	Weight Kg
3365008	R21430113	113	18.100

### Contents

#### 13 Piece-1/4 DR. 6PT Sockets:

4, 4, 5, 5, 5, 6, 7, 8, 9, 10, 11, 12, 13, 14mm

#### 19 Piece-1/2" Sockets:

10, 11, 12, 13, 14, 15, 16, 17, 18, 19, 20, 21, 22, 23, 24, 27, 28, 30, 32mm

#### 4 Piece-1/2" Deep Sockets: 14, 15, 17, 19mm

1 Piece-1/4" Quick-Release Ratchet

1 Piece-1/4" Universal Joint

2 Piece Extension: 1/4" 50 & 100mm

1 Piece-1/4" Sliding T-Bar.

1 Piece-1/4" 6-1/2 Spinner Handle with Extension.

1 Piece-1/2" Quick-Release Ratchet Handle

2 Piece Spark Plug Socket: 1/2" 16, 21mm

1 Piece-1/2" Universal Joint

1 Piece-1/2" Coupler Adaptor

3 Piece-Hex Key Wrenches: 1.5, 2, 2.5mm

8 Piece-1/4" Deep Sockets: 6, 7, 8, 9, 10, 11, 12, 13mm

2 Piece-Extension Bar: 1/2" 125, 250mm

1 Piece-3/8" T-Bar Adaptor.

1 Piece-250mm Water Pump Pliers.

1 Piece-Linesman Pliers.

18 Piece-1/4. Bit Sockets:

4 Piece-HEX: 3, 4, 5, 6mm

3 Piece-SLOTTED: 4, 5.5, 6.5mm

2 Piece-PHILLIPS: PH1, PH2

2 Piece-POZI: PZ1, PZ2

7 Piece-STAR: T8, T10, T15, T20, T25, T27, T30

15 Piece-5/16" BITS:

4 Piece-HEX: 8, 10, 12, 14mm

3 Piece-SLOTTED: 8, 10, 12mm

2 Piece-PHILLIPS: PH3, PH4

2 Piece-POZI : PZ3, PZ4

4 Piece-STAR: T40, T45, T50, T55

1 Piece-1/2 Drive 5/16 Coupler Adaptor

17 Piece-Combination Spanners: 6, 7, 8, 9, 10, 11, 12, 13, 14, 15, 16, 17, 18, 19, 20, 21, 22mm

# R2143 0095 TOOL ASSORTMENT

95 pieces

- > Lockable.
- > Three easy-slide drawers, incorporating full extension ball bearing slide mechanisms.
- > Retractable spring-loaded handles.
- > Four-compartment rigid sheetmetal tool chest.
- > Central drawer locking mechanism.
- > Plastic inserts.
- > Dimensions: 520 x 310 x 230mm.



**NEW**

Code	No.	Pieces	Weight Kg
3365015	R21430095	95	10.100

## (1) 50PC SOCKET & ACCESSORIES SET

- 13 Piece-1/4 DR. 6PT Sockets:(CR-V)  
4, 4.5, 5, 5.5, 6, 7, 8, 9, 10, 11, 12, 13, 14mm
- 19 Piece-1/2. 6PT Sockets:(CR-V)  
10, 11, 12, 13, 14, 15, 16, 17, 18, 19, 20, 21, 22, 23, 24, 27, 28, 30, 32mm
- 4 Piece-1/2, 6PT Deep Sockets:(CR-V)  
14, 15, 17, 19mm
- 1 Piece-1/4, Quick-Release Ratchet Handle (72 Teeth)  
(CR-V) DR,
- 1 Piece-1/4 Universal Joint (CR-V)
- 2 Piece-1/4 50 & 100mm Extension (CR-V)
- 1 Piece-1/4 Sliding T-Bar. (CR-V)
- 1 Piece-1/4 6-1/2 Spinner Handle with Extension. (CR-V)
- 1 Piece-1/2 Quick-Release Ratchet Handle (72 Teeth)  
(CR-V)
- 2 Piece-1/2 16 21mm (6PT) Spark Plug Socket (CR-V)
- 1 Piece-1/2 Universal Joint (CR-V)
- 1 Piece-1/2 Coupler Adaptor (CR-V)
- 3 Piece-Hex Key Wrenches (CR-V): 1.5, 2, 2.5 MM

## (2) 46PC DEEP SOCKET, BIT SOCKET & PLIERS SET

- 8 Piece-1/4 6PT Deep Sockets:(CR-V)  
6, 7, 8, 9, 10, 11, 12, 13mm
- 1 Piece-1/2 125mm Extension Bar (CR-V)
- 1 Piece-3/8 (F)x1/2 (M) T-Bar Adaptor. (CR-V)
- 1 Piece-250mm (10) Water Pump Pliers.
- 1 Piece-Linesman Pliers.
- 18 Piece-1/4. Bit Sockets:(BIT:S2, ZINC PHOSPHATE FINISHED; Socket:CR-V)  
4 Piece-HEX: 3, 4, 5, 6 MM  
3 Piece-SLOTTED: 4, 5.5, 6.5 MM  
2 Piece-PHILLIPS: PH1, PH2  
2 Piece-POZI: PZ1, PZ2  
7 Piece-STAR: T8, T10, T15, T20, T25, T27, T30
- 15 Piece-5/16 BITS:(L:30mm)(S2)(ZINC PHOSPHATE FINISHED)  
4 Piece-HEX: 8, 10, 12, 14mm  
3 Piece-SLOTTED: 8, 10, 12mm  
2 Piece-PHILLIPS: PH3, PH4  
2 Piece-POZI : PZ3, PZ4  
4 Piece-STAR: T40, T45, T50, T55  
1 Piece-1/2 Drive 5/16 Coupler Adaptor (CR-V)



**R2156 0060**  
**WORKSHOP TOOLKIT**

218 pieces

- > In strong, sheetmetal construction, ideal for the professional workshop
- > Individual locking device on every drawer prevents them from opening when the trolley is in motion
- > Load capacity of 35kg per drawer
- > Central drawer locking mechanism, supplied with two keys
- > Two swivel castors, (one with safety brake)
- > Load capacity of 300kg
- > Red and black powder coated
- > Handle for easy manoeuvrability

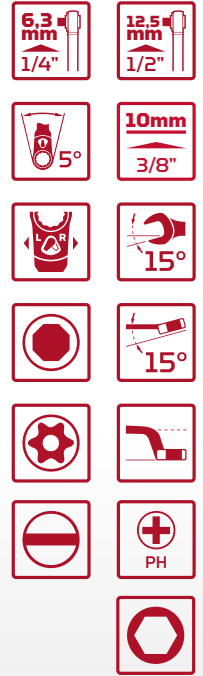

Code	No.	Contents	Weight Kg
<b>3365002</b>	R21010060	R20160006 Tool Trolley	17.400
	(Tools Only)	1/4" 2C lever reversible ratchet, fine-toothed, 72 teeth   150 mm	
<b>3365003</b>	R2150060	1/4" square plug-in handle 165 mm	78.000
	(Tool Assortment in Trolley)	1/4" socket hexagon 4 4.5 5 5.5 6 7 8 9 10 11 12 13 14   25 mm	
		1/4" socket hexagon 4 5 6 7 8 9 10   50 mm	
		1/4" socket TX E4 E5 E6 E7 E8   25 mm	
		1/4" screwdriver bit socket in-hex 4 4.5 6   37 mm	
		1/4" screwdriver bit socket slotted 4 5.5 6.5 7   37 mm	
		1/4" screwdriver bit socket cross-head PH 0 1 2   37 mm	
		1/4" screwdriver bit socket cross-head PZ 0 1 2   37 mm	
		1/4" screwdriver bit socket TX T8 T9 T10 T15 T20 T25 T27 T30   37 mm	
		1/4" screwdriver bit socket TX with drill hole T8 T9 T10 T15 T20 T25 T27 T30   37 mm	
		1/4" socket extension 50 100 mm	
		1/4" sliding T-bar with slider   115 mm	
		1/4" universal joint   32 mm	
		Bit adapter 1/4" sq. x 1/4" hex   25 mm	
		1/4" bits TX T5 T6 T7   25 mm	
		1/4" bits TX with drill hole T7   25 mm	
		1/4" bits TX plus security T10 T15 T20 T25 T27 T30 T40 T45   25 mm	
		1/4" bits multi-point XZN M5 M6 M8   25 mm	
		1/4" bits keyway M5 M6 M7 M8 M9   25 mm	
		5/16" bits in-hex 7 8 10 12 14   30 mm	
		5/16" bits slotted 8 10 12   30 mm	
		5/16" bits cross-head PH 3 4   30 mm	
		5/16" bits cross-head PZ 3 4   30 mm	
		5/16" bits TX T40 T45 T50 T55 T60 T70   30 mm	
		5/16" bits TX with drill hole T40 T45 T50 T55 T60 T70   30 mm	
		3/8" 2C lever reversible ratchet, fine-toothed, 72 teeth   180 mm	
		3/8" socket hexagon 10 11 12 13 14 15 16 17 18 19	
		3/8" socket hexagon 10 11 12 13 14 15   63 mm	
		3/8" socket TX E10 E11 E12 E14 E16 E18	
		3/8" spark plug socket 18 mm   65 mm	
		3/8" socket extension 150 mm	
		3/8" universal joint   49 mm	
		Bit adapter 3/8" square x 5/16" hex   30 mm	
		1/2" 2C lever reversible ratchet, fine-toothed, 72 teeth   250 mm	
		1/2" socket hexagon 10 11 12 13 14 15 16 17 18 19 20 21 22 24 27 30 32	
		1/2" socket hexagon 16 17 18 19 22   77 mm	
		1/2" socket 1/2 TX E20 E24	
		1/2" spark plug socket 16 21 mm   65 mm	
		1/2" socket extension 125 250 mm	
		1/2" universal joint   66 mm	
		Socket extension piece/slider 3/8" x 1/2"   44 mm	
		Bit adapter 1/2" square x 5/16" hex   38 mm	
		Hexagon socket key 1.5 2 2.5 3 4 5 6 mm	
		Combination Spanners 6 7 8 9 10 11 12 13 14 15 16 17 18 19 20 21 22 24 27 30 32 mm	
		Pliers Combination pliers - 180mm, Side Cutters - 160mm, Telephone Pliers - 200mm,	
		Water Pump Pliers, Locking Pliers	
		Screwdrivers Slotted 3 5.5 6.5mm, Cross-Slotted PH0 PH1 PH2	
		Ball Pein Hammer 3/4	
		Allen Keys 1.5 2 2.5 3 4 5 6 8 10	
		Adjustable Wrench 250mm	
		Digital Caliper	
		Heavy Duty Cutting Knife	
		Tape Measure 5M	
		Torch	

**R2156 0113**  
**TOOL ASSORTMENT**

119 pieces

- > Ideal for the professional workshop.
- > Rigid sheetmetal structure.
- > Five standard and one deep easy slide drawers incorporating extra strong ball bearing slider mechanisms.
- > Central drawer locking mechanism.
- > Two swivel castors (one with safety brake) for maximum mobility and safety.
- > Handle for easy manoeuvrability.
- > Load capacity of 300kg.
- > Load capacity per drawer 35kg.
- > Black powder coated.
- > Drawer latch incorporated into each drawer.
- > L=651 x W=585 x H=877mm.



Code	No.	Contents	Weight Kg
3365009	R21560113 (Tool Assortment in Trolley)	13 Piece-1/4 DR. 6PT Sockets:(CR-V) 4, 4.5, 5, 5.5, 6, 7, 8, 9, 10, 11, 12, 13, 14mm 19 Piece-1/2. 6PT Sockets:(CR-V) 10, 11, 12, 13, 14, 15, 16, 17, 18, 19, 20, 21, 22, 23, 24, 27, 28, 30, 32mm 4 Piece-1/2, 6PT Deep Sockets:(CR-V) 14, 15, 17, 19mm 1 Piece-1/4, Quick-Release Ratchet Handle (72 Teeth)(CR-V) DR, 1 Piece-1/4 Universal Joint (CR-V) 2 Piece-1/4 50 & 100mm Extension (CR-V) 1 Piece-1/4 Sliding T-Bar. (CR-V) 1 Piece-1/4 6-1/2 Spinner Handle with Extension. (CR-V) 1 Piece-1/2 Quick-Release Ratchet Handle (72 Teeth)(CR-V) 2 Piece-1/2 16 21mm (6PT) Spark Plug Socket (CR-V) 1 Piece-1/2 Universal Joint (CR-V) 1 Piece-1/2 Coupler Adaptor (CR-V) 3 Piece-Hex Key Wrenches (CR-V): 1.5, 2, 2.5 mm 8 Piece-1/4 6PT Deep Sockets:(CR-V) 6, 7, 8, 9, 10, 11, 12, 13mm 2 Piece-1/2 125 & 250mm Extension Bar (CR-V) 1 Piece-3/8 (F)x1/2 (M) T-Bar Adaptor. (CR-V) 1 Piece-250mm (10) Water Pump Pliers. 1 Piece-Linesman Cutter Pliers. 18 Piece-1/4. Bit Sockets:(BIT:S2, ZINC Phosphate Finished; Socket:CR-V) 4 Piece-HEX: 3, 4, 5, 6 MM 3 Piece-SLOTTED: 4, 5.5, 6.5 MM 2 Piece-PHILLIPS: PH1, PH2 2 Piece-POZI: PZ1, PZ2 7 Piece-TORX®: T8, T10, T15, T20, T25, T27, T30 15 Piece-5/16 BITS:(L:30mm)(S2)(ZINC Phosphate Finished) 17PC-Combination Spanners:(CR-V) 6, 7, 8, 9, 10, 11, 12, 13, 14, 15, 16, 17, 18, 19, 20, 21, 22mm	78.000

**R2188 0019**  
**TOOL PANEL STARTER KIT**

19 pieces

> Tool panel sold seperately



Code	No.	Contents	Weight Kg	
663356	R21880019 (Tool Panel with Tools)	R0910 Combination spanners 8 9 10 11 13 14 17 19mm R38002006 Screwdriver set Slotted: 3 5.5 6.5mm Cross-slotted: PH0 1 2 R28302200 Combination Pliers 200mm R28100010 Water Pump Pliers R92420019 Claw Hammer	R94550005 Tape Measure 5M R93210000 Heavy-Duty Utility Knife Tool Panel Large Storage Tray PA-H1 Hook: 1-Pin, 20 Piece	4.920

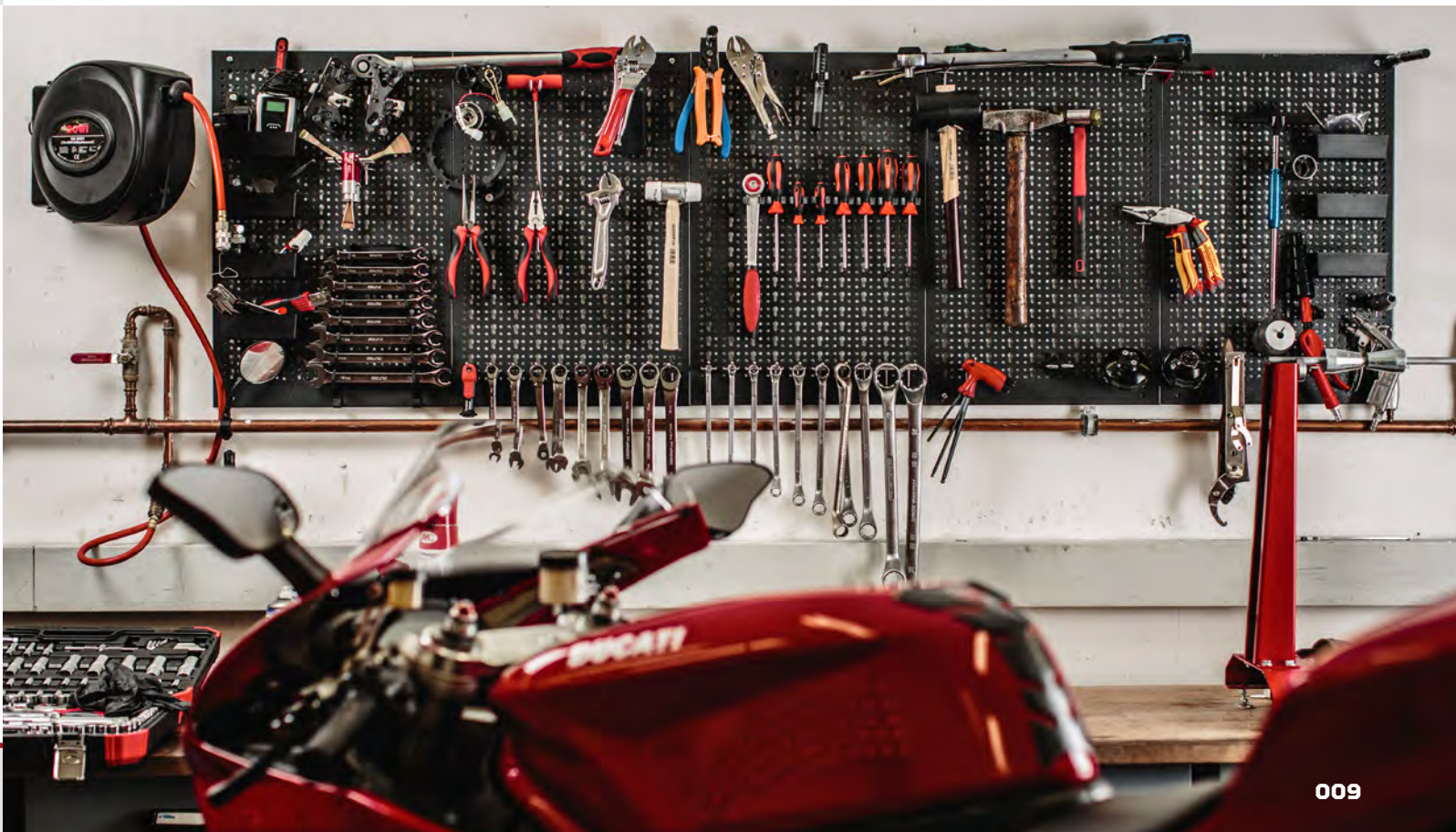

# MOBILE TOOL STORAGE



**ORGANISED.  
SMART**

## **i**

### **STORE, ORGANISE AND TRANSPORT**

- The right tool storage for every application, from simple transport solutions to mobile workstations
- Robust materials and stable constructions for a long service life
- Tool trolleys and workbenches can be combined with foam modules or plastic inserts for optimum workplace organisation

## R2156 0000 SERVICE TROLLEY

1 drawer, empty



- > Ideal for the professional workshop.
- > Rigid sheetmetal structure.
- > Load capacity of 100kg.
- > Red powder coated.
- > Lockable drawer.
- > 3-tier.
- > Dual pegboards on either side.
- > Includes 10-piece screwdriver holder.
- > Dimensions: 806 x 462 x 898 mm.
- > Supplied flat-packed with easy assembly instructions.

# NEW

Code	No.	Width mm	Depth mm	Height mm	Weight Kg
3365019	R21560000	806	462	898	6.200



## R2066 0067 TOOLBOX

5 compartments, empty

- > Smooth and easy opening and closing
- > Maximum access to bottom and middle tray
- > Five compartments
- > Lockable, phosphated and powder coated to prevent corrosion

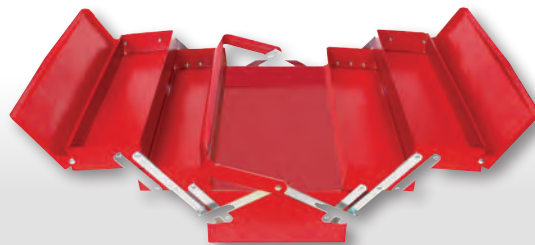

Code	No.	W	D	H	Weight Kg
3301840	R20660067	460	248	220	6.200

## R21020113 TOOL CHEST

4 compartments, empty

- > Lockable.
- > 3 drawers with telescopic full-extension runners
- > Retractable spring-loaded handles.
- > Four-compartment rigid sheetmetal tool chest.
- > Central drawer locking mechanism.



Code	No.	W	D	H	Weight Kg
3365006	R21020113	520	310	230	8.750

## R2016 0006 WORKSHOP TROLLEY MECHANICS

6 drawers, empty

- > In strong, sheetmetal construction, ideal for the professional workshop
- > Individual locking device on every drawer prevents them from opening when the trolley is in motion
- > Load capacity of 35kg per drawer
- > Central drawer locking mechanism, supplied with two keys
- > Two swivel castors, (one with safety brake)
- > Load capacity of 300kg
- > Red and black powder coated
- > Handle for easy manoeuvrability



Code	No.	MAX load capacity 	H	W	D	Weight Kg
3301839	R20160006	300	877	651	585	48.000

# SPANNERS

LEGEND



## TOOLS WITH PURPOSE

- Large assortment with versatile solutions from open-end to ring and ratchet spanners
- Optimised head heights and widths as well as jaw positions for efficient working angles
- Matt-satin surfaces for glare-free work

## R0910xxxx COMBINATION SPANNERS

metric



- > Acc. to DIN 3113, Form A, ISO 3318, ISO 7738
- > Ring offset to 15°
- > Jaw set at 15°



Code	No.	Ø mm	l mm	Weight Kg
3300962	R09100060	6	95	0.016
3300963	R09100070	7	105	0.018
3300964	R09100080	8	110	0.024
3300965	R09100090	9	120	0.031
3300966	R09100100	10	130	0.035
3300967	R09100110	11	140	0.035
3300968	R09100120	12	153	0.050
3300969	R09100130	13	163	0.072
3300970	R09100140	14	173	0.075
3300971	R09100150	15	185	0.090
3300972	R09100160	16	198	0.105
3300973	R09100170	17	210	0.120
3300974	R09100180	18	220	0.155
3300975	R09100190	19	230	0.107
3300976	R09100200	20	240	0.200
3300977	R09100210	21	252	0.240
3300978	R09100220	22	262	0.220
3300979	R09100230	23	262	0.280
3300980	R09100240	24	282	0.300
3300981	R09100250	25	292	0.330
3300982	R09100260	26	302	0.360
3300983	R09100270	27	310	0.400
3300984	R09100280	28	320	0.435
3300985	R09100290	29	330	0.475
3300986	R09100300	30	340	0.500
3300987	R09100320	32	360	0.700

## R0910XXXX

# COMBINATION SPANNER SETS



- > Acc. to DIN 3113, Form A, ISO 3318, ISO 7738
- > Jaw set at 15°
- > In a plastic holder
- > Various handy sets available, made-up of the most popular sizes
- > Eye-catching packaging

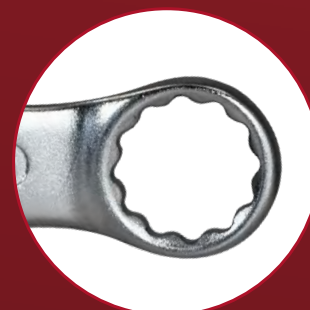

Code	No.	Contents	Pieces	Weight Kg
3300988	R09105008	8 9 10 11 13 14 17 19 mm	8	0.600
3300990	R09105012	10 11 12 13 14 17 19 22 24 27 30 32 mm	12	2.500
3300994	R09105017	6 7 8 9 10 11 12 13 14 15 16 17 18 19 20 21 22 mm	17	1.800
3300991	R09105021	6 7 8 9 10 11 12 13 14 15 16 17 18 19 20 21 22 24 27 30 32 mm	21	4.712

## R0710XXXX COMBINATION RATCHET SPANNERS

metric



- > Based on DIN 3113, ISO 3318
- > Straight pattern
- > Jaw set at 15°



Code	No.	Ø mm	l mm	Weight Kg	Code	No.	Ø mm	l mm	Weight Kg	Code	No.	Ø mm	l mm	Weight Kg
3300828	R07100080	8	136	0.047	3300833	R07100130	13	180	0.100	3300838	R07100180	18	239	0.220
3300829	R07100090	9	143	0.065	3300834	R07100140	14	193	0.110	3300839	R07100190	19	250	0.248
3300830	R07100100	10	160	0.066	3300835	R07100150	15	200	0.149	3300841	R07100210	21	285	0.412
3300831	R07100110	11	168	0.077	3300836	R07100160	16	216	0.180	3300843	R07100240	24	325	0.504
3300832	R07100120	12	174	0.085	3300837	R07100170	17	233	0.200					

### R0720XXXX COMBINATION RATCHET SPANNER SET

reversible, metric



- > Based on DIN 3113, ISO 3318
- > Ring offset to 15°, reversible for right and left hand operation
- > Ratchet mechanism with 72 teeth
- > In the holder



Code	No.	Contents	Pieces	Weight Kg
3300872	R07205005	8 10 13 17 19 mm	5	0.688
3300873	R07205012	8 9 10 11 12 13 14 15 16 17 18 19 mm	12	1.576

### R0720XXXX COMBINATION RATCHET SPANNER SET

with adapters, metric, 12 pieces



- > In accordance with DIN 3113 ISO 3318
- > Ring offset to 15°, reversible for right and left hand operation
- > Ratchet mechanism with 72 teeth
- > In rugged plastic case



Code	No.	Contents	Pieces	Weight Kg
3300059	R07203012	Combination ratchet spanners 8 10 12 13 15 17 18 19 mm Square end drive adaptor 1/4" for Size 10 mm, 3/8" for Size 13 mm, 1/2" for Size 19 mm Bit adaptor 1/4" for Size 10 mm	12	15.680

### R47001004 SQUARE DRIVE ADAPTER SET

for ratchet spanners, 4 pieces

- > For secure connection of ratchet wrench and socket
- > Push-button release
- > Square drive in acc. with DIN 3120, ISO 1174, with ball locking device
- > Bit holder with hexagon drive in acc. with DIN 3126 - C 6.3 (1/4")

- > Matt chrome-plated
- > Chrome-vanadium steel

WHILE STOCKS LAST



Code	No.	Contents	Pieces	Weight Kg
3300061	R47001004	External hex 19 mm x external sq. 1/2" for sockets External hex 13 mm x external sq. 3/8" for sockets External hex 10 mm x external sq. 1/4" for sockets External hex 10 mm x in-hex 1/4" for all 1/4" bits	4	0.100

### R0110XXXX DOUBLE RING SPANNER

metric

- > Acc. to DIN 838, ISO 3318, ISO 1085, ISO 10104
- > 5° offset
- > Thin-walled rings
- > Chrome-vanadium steel
- > Matt satin chrome-plated finish

WHILE STOCKS LAST



Code	No.	mm	mm	Weight Kg
3300901	R01100607	6 x 7	175	0.055
3300902	R01100809	8 x 9	185	0.070
3300904	R01101011	10 x 11	198	0.090
3300906	R01101213	12 x 13	215	0.115
3300908	R01101415	14 x 15	228	0.150
3300909	R01101617	16 x 17	246	0.190
3300910	R01101719	17 x 19	268	0.235
3300911	R01101819	18 x 19	268	0.235



### R0110XXXX DOUBLE RING SPANNER SET



Code	No.	Contents	Pieces	Weight Kg
3300926	R01105008	6x7 8x9 10x11 12x13 14x15 16x17 18x19 20x22 mm	8	1.400
3300928	R01105012	6x7 8x9 10x11 12x13 14x15 16x17 18x19 20x22 mm	12	3.550

### R0510XXXX DOUBLE OPEN-ENDED SPANNERS



- > Acc. to DIN 895, ISO 3318, ISO 1085
- > Jaw set at 15°

WHILE STOCKS LAST

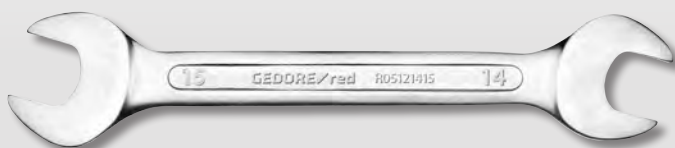

### R0510XXXX DOUBLE OPEN-ENDED SPANNER SETS



Code	No.	Ø mm	↳ mm ↲	Weight Kg	Code	No.	Ø mm	↳ mm ↲	Weight Kg
3300930	R05100607	6 x 7	122	0.025	3300943	R05101719	17 x 19	222	0.155
3300931	R05100809	8 x 9	140	0.040	3300944	R05101819	18 x 19	222	0.155
3300933	R05101011	10 x 11	157	0.040	3300946	R05102022	20 x 22	236	0.210
3300934	R05101013	10 x 13	172	0.060	3300947	R05102123	21 x 23	247	0.240
3300935	R05101213	12 x 13	172	0.055	3300948	R05102224	22 x 24	247	0.240
3300940	R05101415	14 x 15	188	0.100	3300949	R05102426	24 x 26	266	0.300
3300942	R05101617	16 x 17	205	0.110	3300950	R05102427	24 x 27	266	0.300

Code	No.	Contents	Pieces	Weight Kg
3300959	R05105008	6x7 8x9 10x11 12x13 14x15 16x17 18x19 20x22 mm	8	0.700
3300960	R05105012	6x7 8x9 10x11 12x13 14x15 16x17 18x19 20x22 21x23 24x27 25x28 30x32 mm	12	2.420

### R0135XXXX HALF MOON RING SPANNER

- > For tight spaces
- > Thin walled rings



Code	No.	Ø mm	↳ mm ↲	Weight Kg	Code	No.	Ø mm	↳ mm ↲	Weight Kg	Code	No.	Ø mm	↳ mm ↲	Weight Kg
3301113	R01351012	10 x 12	128	0.045	3301115	R01351315	13 x 15	168	0.100	3301117	R01351517	15 x 17	184	0.115
3301114	R01351113	11 x 13	150	0.075	3301116	R01351416	14 x 16	184	0.115					

### R0310XXXX ADJUSTABLE SPANNERS



- > Acc. to DIN 3117, Form A
- > Jaw set at 15°
- > Polished head with lasered scale
- > High torque
- > Nickel chrome plated



Code	No.	↳ inch ↲	↳ mm ↲	mm	Weight Kg
3300997	R03100008	8	200	30	0.250
3300998	R03100010	10	250	34	0.420
3300999	R03100012	12	300	41	0.700

### R0380XXXX ADJUSTABLE SPANNERS

- > Acc. to DIN 3117, Form A
- > Jaw set at 15°
- > Swedish pattern, roller with left hand thread
- > High torque
- > Blackened finish



Code	No.	↳ inch ↲	↳ mm ↲	mm	Weight Kg
3301060	R03800006	6	150	20	0.140
3301061	R03800008	8	200	25	0.280
3301062	R03800010	10	250	30	0.480
3301063	R03800012	12	300	36	0.750

# RANGE OF SOCKETS



ROBUST  
MULTI-TALENT



## RATCHETS WITH FUNCTION

- Full range of sockets and accessories in 1/4", 3/8" and 1/2" drive
- Ratchets in 1/4", 3/8" and 1/2" drive, fine toothed for clockwise and anti-clockwise operation
- Ratchets with oval heads for minimum return angle and easy access in tight spaces

**R40000027**  
**2C REVERSIBLE**  
**RATCHET 1/4"**



- > Lever for reversible clockwise/anticlockwise operation
- > Push-button release
- > Fine-toothed
- > For sockets, accessories etc. with square drive as per DIN 3120 - C.6.3, ISO 1174, with ball retention groove



Code	No.	■"	■	∠°	┆mm┆	Weight Kg
3300158	R40000027	1/4"	6.3	5	150	0.122

**R4100XXXX**  
SOCKET 1/4"

hexagon, metric



- > Hand-operated, knurled grip
- > Acc. to DIN 3124, ISO 2725
- > Square drive as per DIN 3120 - C 6.3, ISO 1174, with ball retention groove



Code	No.	mm	mm	Ø1	Ø2	Weight Kg
3300064	R41000403	4	25	6,7	12,0	0.012
3300065	R41004503	4,5	25	7,2	12,0	0.013
3300066	R41000503	5	25	7,8	12,0	0.013
3300067	R41005503	5,5	25	8,5	12,0	0.013
3300068	R41000603	6	25	9,1	12,0	0.014
3300069	R41000703	7	25	10,5	12,0	0.012
3300070	R41000803	8	25	11,3	12,0	0.014
3300071	R41000903	9	25	12,0	13,0	0.012
3300072	R41001003	10	25	12,7	14,5	0.014
3300073	R41001103	11	25	14,0	16,0	0.017
3300074	R41001203	12	25	15,0	17,0	0.020
3300075	R41001303	13	25	16,0	18,0	0.020
3300076	R41001403	14	25	18,0	19,7	0.018

**R4255XXXX**  
ALLEN KEY SOCKET 1/4"

for in-hex screws



- > Hand-operated, knurled grip
- > Acc. to DIN 7423
- > Square drive as per DIN 3120 - C 6.3, ISO 1174, with ball retention groove



Code	No.	mm	mm	mm	Ø	Weight Kg
3300123	R42550306	3	37	15,0	12	0.016
3300124	R42550406	4	37	15,0	12	0.016
3300125	R42550506	5	37	15,0	12	0.017
3300126	R42550606	6	37	15,0	12	0.015
3300127	R42550806	8	37	15,0	12	0.020
3300128	R42551006	10	37	15,0	12	0.020

**R4120XXXX**  
FEMALE TX SOCKET 1/4"

for external TX screws



- > Hand-operated, knurled grip
- > Square drive as per DIN 3120 - C 6.3, ISO 1174, with ball retention groove

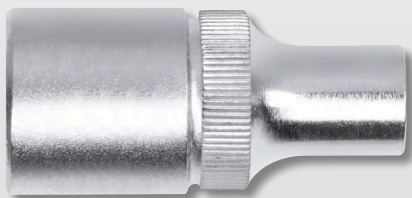

Code	No.	mm	mm	Ø1	Ø2	Weight Kg
3300102	R41200203	E5	25	7,2	12,0	0.013
3300103	R41200303	E6	25	8,2	12,0	0.014
3300104	R41200403	E7	25	9,0	12,0	0.014
3300105	R41200503	E8	25	13,3	12,0	0.015
3300106	R41200703	E10	25	12,5	13,2	0.015

**R4245XXXX**  
MALE TX SOCKET 1/4"

for recessed TX screws



- > Hand-operated, knurled grip
- > Square drive as per DIN 3120 - C 6.3, ISO 1174, with ball retention groove



Code	No.	mm	mm	mm	Ø	Weight Kg
3300107	R42451106	T10	37	15,0	12	0.015
3300108	R42451206	T15	37	15,0	12	0.016
3300109	R42451306	T20	37	15,0	12	0.016
3300110	R42451406	T25	37	15,0	12	0.016
3300111	R42451506	T27	37	15,0	12	0.016
3300112	R42451606	T30	37	15,0	12	0.016
3300113	R42451806	T40	37	15,0	12	0.017

**R4510XXXX**  
EXTENSIONS 1/4"



- > For hand-operated sockets
- > Square drive as per DIN 3120 - C 6.3, ISO 1174, with ball retention groove
- > Coupler based on DIN 3120 - A 6.3, ISO 1174, with ball lock



Code	No.	■ "	■ mm	↳ mm ↳	Weight Kg
<b>3300140</b>	R45100009	1/4"	6,3	50	0.025
<b>3300141</b>	R45100019	1/4"	6,3	100	0.050
<b>3300142</b>	R45100029	1/4"	6,3	150	0.065

**R45300005**  
UNIVERSAL JOINT 1/4"



- > Screwed-on joint
- > Acc. to DIN 3123 - C 6,4
- > For hand-operated sockets
- > Square drive as per DIN 3120 - C 6.3, ISO 1174, with ball retention groove
- > Coupler based on DIN 3120 - A 6.3, ISO 1174, with ball lock



Code	No.	■ "	■ mm	↳ mm ↳	Weight Kg
<b>3300144</b>	R45300005	1/4"	6,3	33	0.024



**R45200022**  
SLIDING T-BAR WITH SLIDER 1/4"



- > Acc. to DIN 3122, ISO 3315
- > For hand-operated sockets
- > Coupler based on DIN 3120 - A 6.3, ISO 1174, with ball lock



Code	No.	■ "	■ mm	↳ mm ↳	Weight Kg
<b>3300143</b>	R45200022	1/4"	6,3	115	0.038



### R38950001 DRIVING HANDLE 1/4"

- > For hand-operated sockets and accessories with square drive as per DIN 3120, ISO 1174, ball locking device
- > 2-component-handle for a hands-friendly transfer of force
- > Coupler in acc. with DIN 3120 - A 6.3, ISO 1174, with ball locking device
- > square socket in handle suitable for ratchet drive with DIN 3120 - C 6.3, ISO 1174, with ball catch groove



Code	No.	■"	■mm	↳mm↳	Weight Kg
3301344	R38950001	1/4"	6,3	171	0.120

### R47110009 SOCKET HOLDER 1/4"



- > For driving sockets and screwdriver bit sockets
- > Coupler based on DIN 3120 - A 6.3, SO 1174, with ball lock
- > Hex drive as per DIN 3126 - C 6.3 (1/4") for use in chucks



Code	No.	■"	◆"	↳mm↳	Weight Kg
3300150	R47110009	1/4"	1/4"	50	0.016

### R47120011 QUICK-CHANGE BIT HOLDER 1/4"



with magnet

- > Quick-grip system for hex bits as per DIN 3126 - C 6.3 + E 6.3 (1/4")
- > Hex drive as per DIN 3126 - C 6.3 (1/4") for use in chucks
- > Release for bit ejection



Code	No.	◆"	◇"	↳mm↳	Weight Kg
3300148	R47120011	1/4"	1/4"	60	0.030

### R47110011 BIT HOLDER 1/4"



with magnet

- > Acc. to DIN 7427
- > For bits with external hexagon drive to DIN 3126 - C 6.3 E 6.3 (1/4"), external hexagon drive to DIN 3126 - C 6.3 (1/4") for use in chucks



Code	No.	◆"	◇"	↳mm↳	Weight Kg
3300146	R47110011	1/4"	1/4"	60	0.022

**R50000027**  
2C REVERSIBLE  
RATCHET 3/8"



- > Lever for reversible clockwise/anticlockwise operation
- > Push-button release
- > Fine-toothed
- > For sockets, accessories etc. with square drive as per DIN 3120 - C 6.3, ISO 1174, with ball retention groove

WHILE STOCKS LAST



Code	No.	10mm 3/8"	5°	180	Weight Kg
3300224	R50000027	3/8"	5	180	0.282

**R55200039**  
SLIDING T-BAR 3/8"



- > Acc. to DIN 3122, ISO 3315
- > For hand-operated sockets
- > Coupler based on DIN 3120 - A 10, ISO 1174, with ball lock



Code	No.	10mm 3/8"	200	Weight Kg
3300242	R55200039	3/8"	200	0.190

**R5510XXXX**  
SOCKET EXTENSION  
3/8"



- > For hand-operated sockets
- > Square drive as per DIN 3120 - C 10, ISO 1174, with ball retention groove
- > Coupler based on DIN 3120 - A 10, ISO 1174, with ball lock



Code	No.	10mm 3/8"	125	Weight Kg
3300218	R55100024	3/8"	125	0.100
3300219	R55100029	3/8"	150	0.150

**R5100XXXX**  
SOCKET 3/8"

hex, metric, short



- > Hand-operated, knurled grip
- > Acc. to DIN 3124, ISO 2725-1
- > Square drive as per DIN 3120 - C 10, ISO 1174, with ball retention groove



Code	No.	10mm 3/8"	28	Ø1	Ø2	Weight Kg
3300164	R51000604	6	28	10,0	17,0	0.019
3300165	R51000704	7	28	10,6	17,0	0.019
3300166	R51000804	8	28	11,8	17,0	0.020
3300167	R51000904	9	28	13,2	17,0	0.021
3300168	R51001004	10	28	14,2	17,0	0.021
3300169	R51001104	11	28	15,6	17,0	0.021
3300170	R51001204	12	28	17,0	18,0	0.024
3300171	R51001304	13	28	18,0	18,0	0.029
3300172	R51001404	14	28	19,5	19,0	0.032

Code	No.	10mm 3/8"	28	Ø1	Ø2	Weight Kg
3300173	R51001504	15	28	21,0	20,0	0.036
3300174	R51001604	16	28	22,0	21,0	0.039
3300175	R51001704	17	30	23,5	22,0	0.053
3300176	R51001804	18	30	24,5	23,0	0.057
3300177	R51001904	19	30	26,0	24,0	0.061
3300178	R51002004	20	32	28,0	25,0	0.060
3300179	R51002104	21	32	28,0	26,0	0.074
3300180	R51002204	22	32	30,0	28,0	0.088

**R6060006**  
**2C RATCHET HANDLE WITH COUPLER**  
**1/2"**



- > Square coupler for clockwise/anti-clockwise operation
- > Acc. to DIN 3122, ISO 3315
- > Also suitable for use with stepped keys and radiator nipple keys
- > For sockets, accessories etc. with square drive as per DIN 3120 - C 6.3, ISO 1174, with ball retention groove



**R60110009**  
**2C SWIVEL-HEAD TELESCOPIC RATCHET**  
**1/2"**,



reversible

- > Telescopic shaft lockable in 5 positions
- > Ratchet head swivels through 180°
- > Ring for reversing clockwise/anticlockwise direction
- > For sockets, accessories etc. with square drive as per DIN 3120 - C 6.3, ISO 1174, with ball retention groove

WHILE STOCKS LAST



**R60000027**  
**2C REVERSIBLE RATCHET**  
**1/2"**



- > Lever for reversible clockwise/anticlockwise operation
- > Push-button release
- > Fine-toothed
- > For sockets, accessories etc. with square drive as per DIN 3120 - C 6.3, ISO 1174, with ball retention groove



Code	No.	"	°	mm	mm
3300412	R6060006	1/2"	12	270	0.560

Code	No.	"	°	mm	mm	mm
3300523	R60110009	1/2"	10	430-580	70	1.292

Code	No.	"	°	mm	mm
3300410	R60000027	1/2"	5	250	0.586



**R6100XXXX**  
SOCKET 1/2"

hex, metric, long

- > Hand-operated, knurled grip
- > Acc. to DIN 3124, ISO 2725-1
- > Square drive as per DIN 3120 - C 12.5, ISO 1174, with ball retention groove



**R6255XXXX**  
ALLEN KEY  
SOCKET 1/2"

hex, metric, short

- > Hand-operated, knurled grip
- > Acc. to DIN 7422
- > Square drive as per DIN 3120 - C 12.5, ISO 1174, with ball retention groove



Code	No.	mm	mm	Ø1	Ø2	Weight Kg
3300304	R61001014	10	77	15,3	22,2	0.073
3300305	R61001114	11	77	16,5	22,2	0.080
3300306	R61001214	12	77	17,8	22,2	0.090
3300307	R61001314	13	77	19,0	22,2	0.096
3300308	R61001414	14	77	20,2	22,2	0.100
3300309	R61001514	15	77	21,3	22,2	0.110
3300310	R61001614	16	77	23,2	22,2	0.114
3300311	R61001714	17	77	24,2	23,0	0.126
3300312	R61001814	18	77	25,0	23,0	0.131
3300313	R61001914	19	77	27,0	24,0	0.161
3300314	R61002014	20	77	28,0	24,0	0.167
3300315	R61002114	21	77	29,0	24,0	0.192
3300316	R61002214	22	77	30,0	26,0	0.192
3300318	R61002414	24	77	32,0	28,0	0.214
3300319	R61002714	27	77	36,0	30,0	0.310
3300320	R61003014	30	77	40,0	34,0	0.355
3300321	R61003214	32	77	42,0	36,0	0.408

Code	No.	mm	mm	mm	Ø	Weight Kg
3300359	R62550510	5	55	17,0	22	0.064
3300360	R62550610	6	55	17,0	22	0.064
3300361	R62550710	7	55	17,0	22	0.068
3300362	R62550810	8	55	17,0	22	0.068
3300363	R62550910	9	55	17,0	22	0.078
3300364	R62551010	10	55	17,0	22	0.080
3300365	R62551110	11	55	17,0	24	0.112
3300366	R62551210	12	55	17,0	24	0.112
3300367	R62551410	14	55	17,0	24	0.136
3300368	R62551710	17	55	17,0	26	0.174

**R6120XXXX**  
FEMALE TX SOCKET 1/2"

for external TX screws

- > Hand-operated, knurled grip
- > Square drive as per DIN 3120 - C 12.5, ISO 1174, with ball retention groove



**R6255XXXX**  
ALLEN KEY  
SOCKET 1/2"

hex, metric, long

- > Hand-operated, knurled grip
- > Acc. to DIN 7422
- > Square drive as per DIN 3120 - C 12.5, ISO 1174, with ball retention groove



WHILE STOCKS LAST

Code	No.	mm	mm	Ø1	Ø2	Weight Kg
3300349	R61200706	E10	38	13,1	22,0	0.052
3300350	R61200806	E11	38	13,8	22,0	0.054
3300351	R61200906	E12	38	14,9	22,0	0.052
3300352	R61201106	E14	38	16,7	22,0	0.052
3300353	R61201306	E16	38	18,7	22,0	0.056
3300354	R61201506	E18	38	20,3	22,0	0.054
3300355	R61201706	E20	38	22,3	24,0	0.062
3300356	R61201807	E22	40	24,3	26,0	0.078
3300357	R61201907	E24	41	26,3	28,0	0.094

Code	No.	mm	mm	mm	Ø	Weight Kg
3300379	R62550719	7	100	62,0	22	0.084
3300380	R62550819	8	100	62,0	22	0.090
3300381	R62551019	10	100	62,0	22	0.150
3300382	R62551219	12	100	62,0	24	0.190
3300383	R62551419	14	100	62,0	24	0.220
3300384	R62551719	17	100	62,0	26	0.228

**R6110XXXX**  
SOCKET 1/2"

bi-hex, metric, short



- > Hand-operated, knurled grip
- > Acc. to DIN 3124, ISO 2725-1
- > Square drive as per DIN 3120 - C 12.5, ISO 1174, with ball retention groove



Code	No.	Ø	↳mm↳	Ø1	Ø2	⚖️
3300323	R61100806	8	38	12,4	22,2	0.050
3300324	R61100906	9	38	14,2	22,2	0.050
3300325	R61101006	10	38	15,3	22,2	0.050
3300326	R61101106	11	38	16,5	22,2	0.051
3300327	R61101206	12	38	17,8	22,2	0.052
3300328	R61101306	13	38	19,0	22,2	0.052
3300329	R61101406	14	38	20,2	22,2	0.054
3300330	R61101506	15	38	21,3	22,2	0.054

Code	No.	Ø	↳mm↳	Ø1	Ø2	⚖️
3300331	R61101606	16	38	23,2	22,2	0.060
3300332	R61101706	17	38	24,2	23,0	0.063
3300333	R61101806	18	38	25,0	23,0	0.066
3300334	R61101906	19	38	27,0	24,0	0.080
3300335	R61102006	20	38	28,0	24,0	0.077
3300336	R61102106	21	38	29,0	24,0	0.091
3300337	R61102206	22	38	30,0	26,0	0.092
3300338	R61102306	23	38	31,0	28,0	0.102

Code	No.	Ø	↳mm↳	Ø1	Ø2	⚖️
3300339	R61102406	24	38	32,0	28,0	0.105
3300341	R61102607	26	42	35,0	29,0	0.147
3300342	R61102707	27	42	36,0	30,0	0.150
3300343	R61102807	28	42	37,0	30,0	0.175
3300345	R61103007	30	42	40,0	34,0	0.200
3300346	R61103207	32	42	42,0	36,0	0.219

**R61021612**  
SPARK PLUG SOCKET 1/2"



- > Hand-operated, knurled grip
- > Rubber insert for holding the spark plug
- > Acc. to DIN 3124, ISO 2725-1
- > Square drive as per DIN 3120 - C 12.5, ISO 1174, with ball retention groove



Code	No.	Ømm	□"	□	↳mm↳	Ø	Weight Kg
3300401	R61021612	16,0	1/2"	12,5	65	21,7	0.090

**R61022112**  
SPARK PLUG SOCKET 1/2"



square drive

- > Drive hexagon with 23 mm wrench size
- > Hand-operated, knurled grip
- > Rubber insert for holding the spark plug
- > Acc. to DIN 3124, ISO 2725-1
- > Square drive as per DIN 3120 - C 12.5, ISO 1174, with ball retention groove



Code	No.	Ømm	□"	□	↳mm↳	Ø	Weight Kg
3300402	R61022112	21,0	1/2"	12,5	65	27,7	0.138

**R6245XXXX**  
**MALE TX SOCKET 1/2"**

for recessed TX screws



- > Hand-operated, knurled grip
- > Square drive as per DIN 3120 - C 12.5, ISO 1174, with ball retention groove



Code	No.		↳ mm ↳		Ø	Weight Kg
3300391	R62451310	T20	55	17,0	22	0.058
3300392	R62451410	T25	55	17,0	22	0.058
3300393	R62451510	T27	55	17,0	22	0.059
3300394	R62451610	T30	55	17,0	22	0.059
3300395	R62451810	T40	55	17,0	22	0.063
3300396	R62451910	T45	55	17,0	22	0.064
3300397	R62452110	T50	55	17,0	22	0.065
3300398	R62452210	T55	55	17,0	22	0.074
3300399	R62452310	T60	55	17,0	24	0.100

**R6510XXXX**  
**EXTENSIONS 1/2"**



- > For hand-operated sockets
- > Square drive as per DIN 3120 - C 12.5, ISO 1174, with ball retention groove
- > Coupler based on DIN 3120 - A 12.5, ISO 1174, with ball lock



Code	No.	■ "	■ mm	↳ mm ↳	Weight Kg
3300403	R65100014	1/2"	12,5	75	0.100
3300404	R65100024	1/2"	12,5	125	0.180
3300406	R65100049	1/2"	12,5	250	0.430

**R65200049**  
**SLIDING T-BAR 1/2"**



- > Acc. to DIN 3122, ISO 3315
- > For hand-operated sockets
- > Coupler based on DIN 3120 - A 12.5, ISO 1174, with ball lock



Code	No.	■ "	■ mm	↳ mm ↳	Weight Kg
3300408	R65200049	1/2"	12,5	250	0.368

**R65300012**  
**UNIVERSAL JOINT 1/2"**



- > Screwed-on joint
- > Acc. to DIN 3123 - C 12,6
- > For hand-operated sockets
- > Square drive as per DIN 3120 - C 12.5, ISO 1174, with ball retention groove
- > Coupler based on DIN 3120 - A 12.5, ISO 1174, with ball lock



Code	No.	□ "	□ mm	■ "	■ mm	↳ mm ↳	Weight Kg
3300407	R65300012	1/2"	12,5	1/2"	12,5	66	0.134



# SOCKET SETS

*PERFECT  
SELECTION*

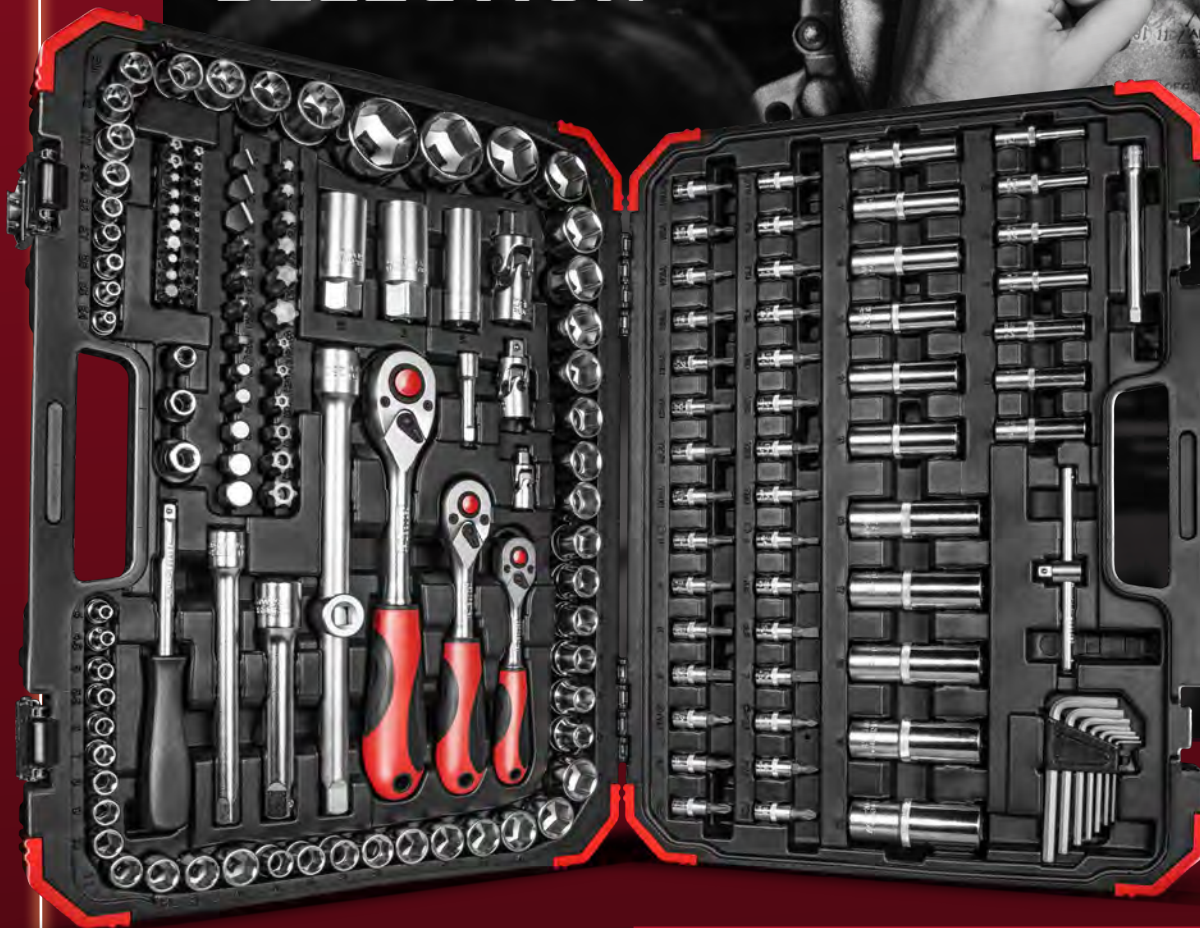

**i**

## ALWAYS THE RIGHT SOLUTION

- Large selection of practical socket sets in 1/4", 3/8" and 1/2" for universal or specialised use
- Available in a robust sheet steel case with foam insert or in a lightweight moulded case
- Organised storage and safe transport

**R49003016**  
SOCKETSET  
1/4"

16 pieces



- > For hand-operation
- > Plastic case in GEDORE red Design



Code	No.	Contents	Weight Kg
3300050	R49003016	1/4" 2C lever-action ratchet fine-toothed, 72 teeth   150 mm 1/4" Socket spanner hexagonal SW 4 4.5 5.5 6 7 8 9 10 11 12 13   25 mm 1/4" socket extension 100mm 1/4" cross handle with slide   115 mm Bit adapter 1/4" square x 1/4" hex   25 mm	0.620

**R49005037**  
TOOLSET T-HANDLE WITH  
RATCHET 1/4"

37 pieces



- > For hand-operation
- > In-hex for direct mounting of bits as per DIN 3126 - D 6.3
- > Ring for reversing clockwise/anticlockwise direction
- > 9x long all-steel blades with square drive and sockets
- > 1x long all-steel blade with square drive as bit holder or extension
- > Bits in extra plastic holders



Code	No.	Contents	Weight Kg
3300025	R49005037	2C ratchet hand grip with swivel 1/4" in-hex blade, ring change Socket hexagon 6 7 8 9 10 11 12 13 14 135 mm Bit holder 1/4" hex x 1/4" hex   135 mm 1/4" bit hexagon 3 4 5 6 8 mm   25 mm	1.335
		1/4" bit slotted 4.5 5.5 6.5   25 mm 1/4" bit cross-head PH 1 2 2.3   25 mm 1/4" bit cross-head PZ 1 2 2.3   25 mm 1/4" bit TX T10 T15 T20 T25 T30 T40   25 mm 1/4" bit TX with drill hole T10 T15 T20 T25   25 mm	

**R49003033**  
SOCKETSET 1/4"

33 pieces



- > For hand-operation
- > Plastic case in GEDORE red Design



Code	No.	Contents	Weight Kg
3300051	R49003033	1/4" 2C lever reversible ratchet, fine-toothed, 72 teeth   150 mm 1/4" square plug-in handle 165 mm 1/4" socket hexagon 4 4.5 5 5.5 6 7 8 9 10 11 12 13 25 mm 1/4" screwdriver bit socket in-hex 3 4 5 6   37 mm 1/4" screwdriver bit socket slotted 4 5 5.5 6   37 mm 1/4" screwdriver bit socket cross-head PH 1 2   37 mm 1/4" screwdriver bit socket cross-head PZ 1 2   37 mm 1/4" screwdriver bit socket TX T15 T20 T25 T30   37 mm 1/4" socket extension 50 100 mm 1/4" universal joint   32 mm Bit adapter 1/4" sq. x 1/4" hex   25 mm	1.310

**R49003046**  
SOCKETSET 1/4"

46 pieces



- > For hand-operation
- > Plastic case in GEDORE red Design

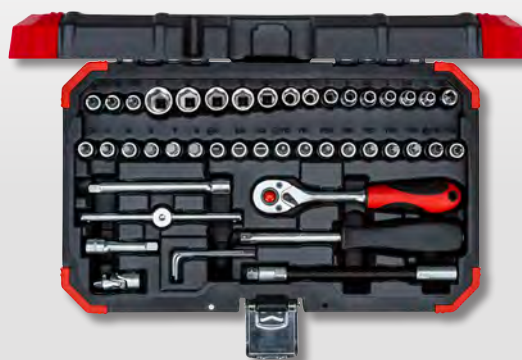

Code	No.	Contents	Weight Kg
3300052	R49003046	1/4" 2K reversible lever ratchet fine-toothed, 72 teeth   150 mm 1/4" square socket 165 mm 1/4" socket hexagon SW 4 4.5 5 5.5 6 7 8 9 10 11 12 13 14   25 mm 1/4" screwdriver bit socket hexagon socket inner 3 4 5 6 7 8   37 mm 1/4" screwdriver bit socket slot 4 5 5.5 6   37 mm 1/4" Screwdriver bit socket Phillips PH 1 2 3   37 mm 1/4" Screwdriver bit socket Phillips PZ 1 2   37 mm 1/4" Screwdriver bit socket TX T10 T15 T20 T25 T27 T30 T40   37 mm 1/4" Socket wrench extension 50 100 mm 1/4" Flexible socket wrench extension 150 mm 1/4" Cross handle with slide   115 mm 1/4" Universal joint   32 mm Bit-Adapter 1/4" square x 1/4" hexagon   25 mm Allen wrench set hexagon SW 1,27 1.5 2 2.5 mm	1.414

**R49005023**  
BIT RATCHET SET  
WITH ADAPTER 1/4"

compact, 23 pieces

- > For hand-operation
- > Rugged plastic box with belt clip

WHILE STOCKS LAST



Code	No.	Contents	Weight Kg
3300026	R49005023	Bit ratchet 1/4" reversible, with drive adapter Socket wrench insert hexagon SW 6 7 8 10 11 12 13 mm 1/4" bits hexagon socket 4 5 6 mm 1/4" bits slot 5,5 mm 1/4" bits cross recess PH 1 2 1/4" bits cross recess PZ 1 2 1/4" bits TX T15 T20 T25 T27 T30 Adapter 1/4" 4kt x 1/4" 6kt bit holder 1/4" 6kt x 1/4" 6kt, with magnet   67 mm	0.380

**R59003026**  
SOCKET SET 3/8"

26 pieces

- > For hand-operation
- > Plastic case in GEDORE red Design

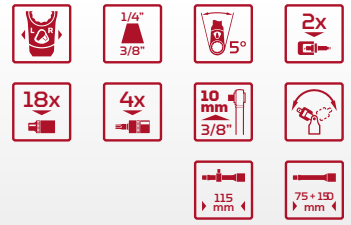

Code	No.	Contents	Weight Kg
3300053	R59003026	3/8" 2K lever reversible ratchet fine-toothed, 72 teeth   180 mm 3/8" socket wrench insert hexagon SW 6 7 8 9 10 11 12 13 14 15 16 17 18 19 20 21 22 24 mm 3/8" spark plug insert SW 16 21 mm   65 mm 3/8" socket wrench extension 75 150 mm 3/8" cross handle with sliding piece 200 mm 3/8" Universal joint 48 mm Reducer 3/8" - 1/4"   27 mm	2.440

**R59003059**  
SOCKET SET 3/8"

59 pieces

- > For hand-operation
- > Plastic case in GEDORE red Design

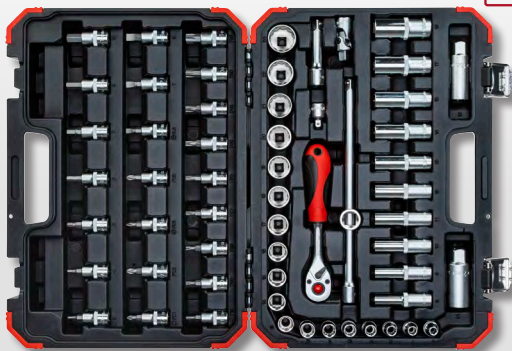

Code	No.	Contents	Weight Kg
3300054	R59003059	3/8" 2C lever reversible ratchet, fine-toothed, 72 teeth   180 mm 3/8" socket hexagon bi-hex 6 7 8 9 10 11 12 13 14 15 16 17 18 19 20 21 22 24 mm 3/8" socket hexagon hex long 8 9 10 11 12 13 14 15 17 19   L.63mm 3/8" spark plug socket 16 21 mm   65 mm 3/4" screwdriver bit socket in-hex 3 4 5 6 7 8 10   48 mm 3/4" screwdriver bit socket slotted 5.5 7 8   48 mm 3/8" screwdriver bit socket cross-head PH 1 2   48 mm 3/8" screwdriver bit socket cross-head PZ 1 2   48 mm 3/8" screwdriver bit socket TX T25 T27 T30 T40 T45 T50 T55   48 mm 3/8" socket extension 75 250 mm 3/8" universal joint   49 mm Reducer 3/8" - 1/4"   27 mm Socket extension piece/slider 3/8" x 1/2"   44 mm	4.800

**R69013024**  
SOCKET SET 1/2"

24 pieces

- > For hand-operation
- > Plastic case in GEDORE red Design



Code	No.	Contents	Weight Kg
3300056	R69013024	1/2" 2C lever reversible ratchet, fine-toothed, 72 teeth   250 mm 1/2" socket bi-hex 10 11 12 13 14 15 16 17 18 19 20 21 22 23 24 26 27 28 30 32 1/2" socket extension 125 250 mm Socket extension piece/slider 3/8" x 1/2"   44 mm	4.750

**R46003092**  
SOCKET SET  
1/4" + 1/2"

92 pieces

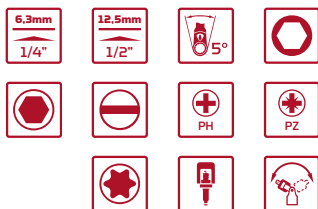

- > For hand-operation
- > Plastic case in GEDORE red Design



Code	No.	Contents	
3300062	R46003092	1/4" 2K lever reversible ratchet fine-toothed, 72 teeth   150 mm 1/4" square plug-in handle   165 mm 1/4" socket wrench insert hexagon SW 4 4.5 5 5.5 6 7 8 9 10 11 12 13 mm 1/4" socket wrench insert hexagon SW 4 5 6 7 8 9 10 11 12 13 mm   50 mm 1/4" socket wrench extension 50 100 mm 1/4" cross handle with sliding piece   115 mm 1/4" universal joint   32 mm bit holder 1/4" hexagonal x 1/4" hexagonal, with magnet   60 mm Bit adaptor 1/4" square x 1/4" hexagon   25 mm Drive adaptor 1/4" hexagon x square with ball lock   25 mm 1/4" bits inner hexagon 3 4 5 6 8 10   25 mm 1/4" bits slot 4 5,5 7   25 mm 1/4" bits cross recess PH 0 1 2 3 4   25 mm 1/4" bits cross recess PZ 1 2 3   25 mm 1/4" bits TX T8 T10 T15 T20 T25 T27 T30 T40   25 mm 5/16" bits TX T45 T50 T55   30 mm 1/2" 2K lever reversible ratchet fine-toothed, 72 teeth   250 mm 1/2" socket wrench insert hexagon SW 10 11 12 13 14 15 17 19 22 24 27 30 32 mm 1/2" spark plug insert 21 mm (13/16")   65 mm 1/2" socket wrench extension 125 250 mm 1/2" universal joint   65 mm Enlarging/sliding piece 3/8" x 1/2"   44 mm Bit adaptor 1/2" square x 5/16" hexagon   38 mm Double-jointed key SW 8x9 10x11 12x13 14x15 mm Combination wrench SW 8 10 12 13 14 17 mm Hexagon Key Wrenches, hexagon SW 1.5 2.2.5 mm	5.850

**R46003094**  
SOCKET SET  
1/4" + 1/2"

94 pieces

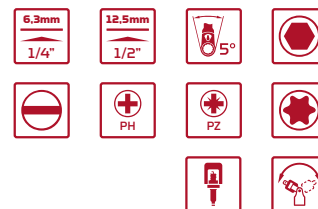

- > For hand-operation
- > Plastic case in GEDORE red Design



Code	No.	Contents	
3300057	R46003094	1/4" 2C lever reversible ratchet, fine-toothed, 72 teeth   150 mm 1/4" square plug-in handle 165 mm 1/4" socket hexagon 4 4.5 5 5.5 6 7 8 9 10 11 12 13 14   25 mm 1/4" socket hexagon 6 7 8 9 10 11 12 13 mm   50 mm 1/4" screwdriver bit socket in-hex 4 4 5 6   37 mm 1/4" screwdriver bit socket slotted 4 5.5 6.5   37 mm 1/4" screwdriver bit socket cross-head PH 1 2   37 mm 1/4" screwdriver bit socket cross-head PZ 1 2   37 mm 1/4" screwdriver bit socket TX T8 T10 T15 T20 T25 T27 T30   37 mm 1/4" socket extension 50 100 mm 1/4" sliding T-bar with slider   115 mm 1/4" universal joint   32 mm 5/16" bits in-hex 8 10 12 14   30 mm 5/16" bits slotted 8 10 12   30 mm 5/16" bits cross-head PH 3 4   30 mm 5/16" bits cross-head PZ 3 4   30 mm 5/16" bits TX T40 T45 T50 T55   30 mm 1/2" 2C lever reversible ratchet, fine-toothed, 72 teeth   250 mm 1/2" socket hex 10 11 12 13 14 15 16 17 18 19 20 21 22 23 24 27 28 30 32 1/2" socket hexagon 14 15 17 19   77 mm 1/2" spark plug socket 16 21 mm   65 mm 1/2" socket extension 125 250 mm 1/2" universal joint   66 mm Socket extension piece/slider 3/8" x 1/2"   44 mm Bit adapter 1/4" square x 5/16" hex   38 mm Hexagon Allen key set 1.5, 2.2.5 mm	6.770

**R46003100**  
SOCKET SET  
1/4" + 1/2"

100 pieces

- > For hand-operation
- > Plastic case in GEDORE red Design

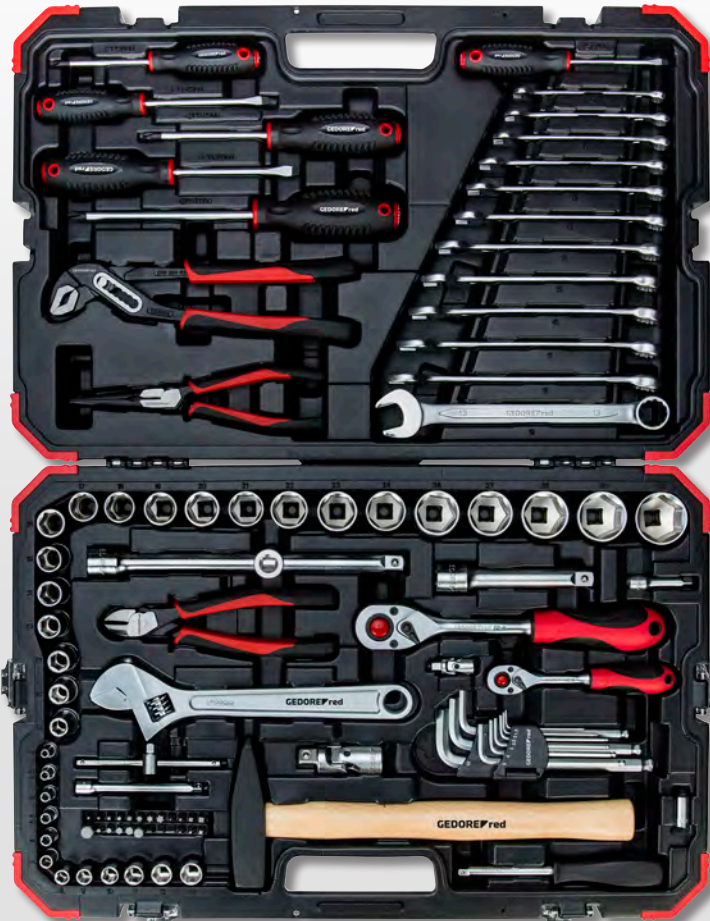
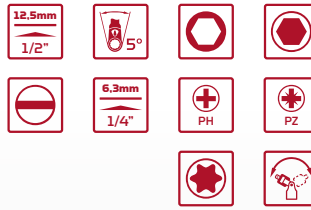

Code	No.	Contents	Weight Kg
3300063	R46003100	1/4" 2C lever reversible ratchet, fine-toothed, 72 teeth   150 mm 1/4" square plug-in handle 165 mm 1/4" socket hexagon 4 4.5 5 5.5 6 7 8 9 10 11 12 13 mm 1/4" socket extension 50 100 mm 1/4" sliding T-bar with slider   115 mm 1/4" universal joint   32 mm Bit adapter 1/4" sq. x 1/4" hex   25 mm 1/4" bits in-hex 3 4 5 6 8 10   25 mm 1/4" bits slotted 4 5 5 7   25 mm 1/4" bits cross-head PH 1 2 3 4   25 mm 1/4" bits cross-head PZ 1 2 3   25 mm 1/4" bits TX T8 T10 T15 T20 T25 T27 T30 T40   25 mm 1/2" 2C lever reversible ratchet, fine-toothed, 72 teeth   250 mm 1/2" socket hex 10 11 12 13 14 15 16 17 18 19 20 21 22 23 24 26 27 28 30 32 mm 1/2" socket extension 125 250 mm 1/2" universal joint   65 mm Socket extension piece/slider 3/8" x 1/2"   44 mm Combination spanners 8 9 10 11 12 13 14 15 16 17 18 19 mm Hexagon Allen key set 1.5 2 2.5 3 4 5 6 8 10 mm Adjustable spanner 10" 250 mm Screwdriver slotted 4 5 5 6.5 Screwdriver cross-head PH 1 2 3 Side cutter 180 mm Telephone pliers 200 mm Water pump pliers 10" 250 mm Hammer 500 g	10.000

**R62558110**  
ALLEN KEY  
SOCKET SET 1/2"

in-hex, metric, on holding rail, 10 pieces



- > Screwdriver bit socket 1/2", hexagon socket, design according to DIN 7422
- > Hand-operated, knurled grip



Code	No.	Contents	Kg
3300027	R62558110	5 6 7 8 9 10 12 14 17 19   55 mm	1.140

**R62458107**  
MALE TX  
SOCKET SET 1/2"

on holding rail, 7 pieces



- > Sockets 1/2", TX
- > Hand-operated, knurled grip



Code	No.	Contents	Kg
3300029	R62458107	TX T20 T25 T27 T30 T40 T45 T50   55 mm	0.560

**R61208007**  
FEMALE TX  
SOCKET SET 1/2"

on holding rail, 7 pieces



- > Sockets 1/2", TX
- > Hand-operated, knurled grip



Code	No.	Contents	Kg
3300028	R61208007	TX E10 E11 E12 E14 E16 E18 E20	0.460



**R46003172**  
**SOCKET SET**  
 1/4" + 3/8" + 1/2"

172 pieces

- › For hand-operation
- › Plastic case in GEDORE red Design

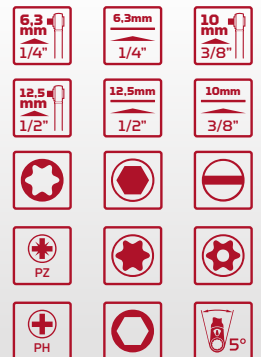
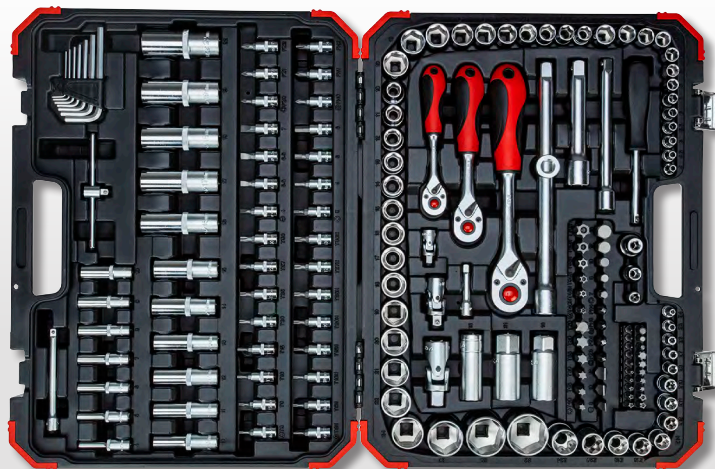

Code	No.	Contents	Weight Kg
3300058	R45603172	1/4" 2K lever reversible ratchet, fine-toothed, 72 teeth   150 mm 1/4" square plug-in handle 165 mm 1/4" socket wrench insert, hexagon SW 4 4.5 5 5.5 6 7 8 9 10 11 12 13 14   25 mm 1/4" socket wrench insert hexagon SW 4 5 6 7 8 9 10   50 mm 1/4" socket wrench insert TX E4 E5 E6 E7 E8   25 mm 1/4" screwdriver bit socket hexagon socket 3 4 5 6   37 mm 1/4" screwdriver bit socket slotted 4 5.5 6.5 7   37 mm 1/4" screwdriver bit socket cross-slotted PH 0 1 2   37 mm 1/4" screwdriver bit socket cross recess PZ 0 1 2   37 mm 1/4" screwdriver bit socket TX T8 T9 T10 T15 T20 T25 T27 T30   37 mm 1/4" screwdriver bit socket TX with bore T8 T9 T10 T15 T20 T25 T27 T30   37 mm 1/4" socket wrench extension 50 100 mm 1/4" T-handle with slider   115 mm 1/4" universal joint   32 mm bit adapter 1/4"square x 1/4" hex.   25 mm 1/4" bits TX T5 T6 T7   25 mm 1/4" bits TX with hole T7   25 mm 1/4" bits TX plus security T10 T15 T20 T25 T27 T30 T40 T45   25 mm 1/4" bits multi-tooth XZN M5 M6 M8   25 mm 1/4" bits keyway M5 M6 M7 M8 M9   25 mm 5/16" bits hexagon socket 7 8 10 12 14   30 mm 5/16" bits slotted 8 10 12   30 mm 5/16" bits cross recess PH 3 4   30 mm 5/16" bits cross recess PZ 3 4   30 mm 5/16" bits TX T40 T45 T50 T55 T60 T70   30 mm 5/16" bits TX with bore T40 T45 T50 T55 T60 T70   30 mm 3/8" 2K lever reversible ratchet, fine-toothed, 72 teeth   180 mm 3/8" socket wrench insert hexagon SW 10 11 12 13 14 15 16 17 18 19 3/8" socket wrench insert hexagon SW 10 11 12 13 14 15   63 mm 3/8" socket wrench insert TX E10 E11 E12 E14 E16 E18 3/8" spark plug insert SW 18 mm   65 mm 3/8" socket wrench extension 150 mm 3/8" universal joint   49 mm bit adapter 3/8"square x 5/16" hex   30 mm 1/2" 2K lever reversible ratchet, fine-toothed, 72 teeth   250 mm 1/2" socket wrench insert hexagon SW 10 11 12 13 14 15 16 17 18 19 20 21 22 24 27 30 32 1/2" socket wrench insert 6-side SW 16 17 18 19 22   77 mm 1/2" socket wrench insert TX E20 E24 1/2" spark plug insert SW 16 21 mm   65 mm 1/2" socket wrench extension 125 250 mm 1/2" universal joint   66 mm enlarging piece / sliding piece 3/8" x 1/2"   44 mm bit adapter 1/2"square x 5/16" hex   38 mm offset screwdriver set hexagon SW 1.5 2 2.5 3 4 5 6 mm	10.500

**R68003030**  
ALLEN KEY SOCKET SET 1/2"

30 pieces



- > For hand-operation
- > Plastic case in GEDORE red Design



Code	No.	Contents	Weight Kg
<b>3301573</b>	R68003030	5 6 7 8 10 12 14 17 19   55 mm 5 6 7 8 10 11 12 13   100 mm 5 6 7 8 10 12 14   140 mm 5 6 7 8 10 12   200 mm	5.400

**R69008012**  
SOCKET SET 1/2"

hex, metric, on holding rail, 12 pieces



- > 2C reversible ratchet 1/2"
- > Socket extension 1/2", 75 mm
- > Socket 1/2", hex



Code	No.	Contents	Weight Kg
<b>3300030</b>	R69008012	2C reversible ratchet 1/2"   250 mm Socket wrench extension 1/2"   75 mm Sockets 1/2" SW 10 11 12 13 14 15 16 17 18 19   38 mm	1.300

**R63003012**  
IMPACT SOCKET SET 1/2"

12 pieces



- > Square drive as per DIN 3121 - G 12,5, ISO 1174
- > Acc. to DIN 3129, ISO 2725-2
- > Machine-operated, fixing with safety ring / pin
- > In rugged plastic case



Code	No.	Contents	Weight Kg
<b>3300574</b>	R63003012	Size 10 11 12 13 14 15 16 17 19 21 22 24 mm	1.598

**R63003008**  
POWER WRENCH SOCKET SET 1/2"

8 pieces



- > Square drive as per DIN 3121 - G 12,5, ISO 1174
- > Acc. to DIN 3129, ISO 2725-2
- > Machine-operated, fixing with safety ring / pin
- > In rugged plastic case

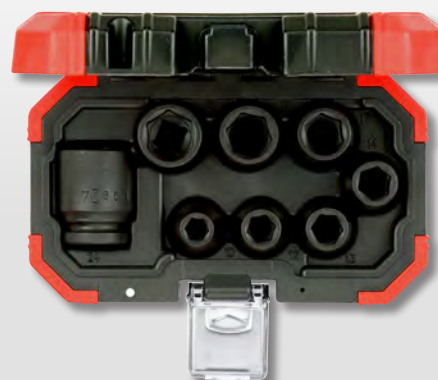

Code	No.	Contents	Weight Kg
<b>3300575</b>	R63003008	Impact wrench 10 12 13 14 17 19 21 24 mm	1.100



**R63043003**  
IMPACT WRENCH SOCKET SET 1/2"

3 pieces



- > Specially for fitting / removing wheels nuts on vehicles
- > Special plastic sleeves for damage-free work on aluminium wheel rims
- > Square drive as per  
DIN 3121 - G 12,5, ISO 1174
- > Acc. to DIN 3129, ISO 2725-2
- > Machine-operated, fixing with safety ring / pin
- > In robust plastic case



Code	No.	Contents	Weight Kg
3300578	R63043003	Power wrench insert SW 17 19 21 mm   86 mm	0.830

**R21702013**  
ON THE ROAD BIKE SET

13 pieces

**NEW**

- > Ergonomic handling with bit ratchet and bit adapter
- > Selection of bits and sockets tailored to the screws and nuts on a bike
- > Clampable bag on the saddle and seat post



Code	No.	Length mm	Width mm	Height mm	Pieces	Weight Kg
3300194	R21702013	90	54	145	13	0.240

**Contents**

Tire lever set, 3 pieces, Bit hexagon socket 3 4 5 6, Bit PH1, Bit TX T25  
Socket 10 mm, Ratchet 1/4", Drive adaptor  
Bit holder with quick release system 66.5 mm, Pocket



# TORQUE WRENCHES

*PURE  
PRECISION*



## CONTROLLED BOLT TIGHTENING

- For controlled right and left hand tightening from 10 to 200 N·m
- Precision confirmed with test certificate according to DIN EN ISO 6789
- Tripping accuracy:  $\pm 3\%$  tolerance of the set scale value, higher than required by the standard



## RX890XXXX

### TORQUE WRENCHES 10-200 Nm

- > Adjustable torque wrench with square drive and integrated ratchet function
- > Audible Torque triggering can clearly be heard and felt
- > Right-hand and left-hand tightening by changing the mushroom head / push-through square
- > Tripping accuracy: +/- 3 % tolerance of the set scale value

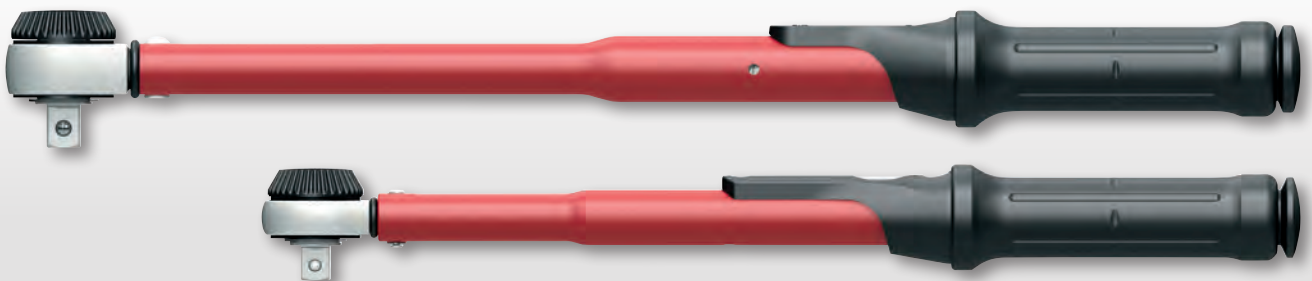

Code	No.	"	mm	N-m	نيوتن متر N-m	« mm »	Weight Kg
3301871	R58900050	3/8"	10	10-50	0,25	334,5	0.476
3301216	R68900100	1/2"	12,5	20-100	0,5	395	1.176
3301217	R68900200	1/2"	12,5	40-200	1	485	1.420

## TORQUE WRENCH WARRANTY & CALIBRATION POLICY

### Warranty

In terms of GEDORE'S warranty policy, all torque wrenches are covered by a lifetime guarantee against defective materials and workmanship. Provided that the tool has been correctly used for its intended purpose and allowances have been made for the wear and tear of moving parts, the torque wrench will be repaired free of charge.

The warranty does not cover torque wrenches which have been misused or which have experienced wear and tear through extensive use.

A warranty return will be assessed by our technical staff and if the return falls outside of our warranty policy, the customer will be notified and quoted for the repair.

### Calibration

A standard calibration and the issue of a test certificate will be provided as standard practice on any repair conducted.

A SANAS calibration and the issue of a SANAS calibration certificate will be done on request at a nominal charge.

### Obsolescence

Please note that while GEDORE uses its best endeavours to carry significant stocks of spares to support its torque wrench product range, some spares for older discontinued items are no longer available. In such cases, repair of the torque wrench may not be possible.

# SCREWDRIVERS



**RAPID  
ROTATIONS**

**i**

**FOR SLOT, PH, PZ, TX AND IN-HEX**

- Blade of high-grade chrome-molybdenum steel
- Tips phosphated, corrosion-protected for low-wear
- Dual-material handles for a hands-friendly transfer of force

**R38002006**  
SCREWDRIVER SET

6 pieces



- > Blade of high-grade chrome-molybdenum steel, chrome-plated
- > Moulded handle forms a firm unit with the blade
- > 5-edge handle head stops it rolling off when put down



Code	No.	Contents	Weight Kg
<b>3301270</b>	R38002006	Slotted screwdriver 3 5,5 6,5 mm Cross-slotted screwdriver PH 0 1 2	0.435

**R38002106**  
SCREWDRIVER SET

6 pieces



- > Blade of high-grade chrome-molybdenum steel, chrome-plated
- > Moulded handle forms a firm unit with the blade
- > 5-edge handle head stops it rolling off when put down



Code	No.	Contents	Weight Kg
<b>3301271</b>	R38002106	Slotted screwdriver 3 5,5 6,5 mm Cross-head screwdriver PZ 0 1 2	0.435

**R38002012**  
SCREWDRIVER SET XXL

12 pieces



- > Blade of high-grade chrome-molybdenum steel, chrome-plated
- > Moulded handle forms a firm unit with the blade
- > 5-edge handle head stops it rolling off when put down



Code	No.	Contents	Weight Kg
<b>3301273</b>	R38002012	Slotted screwdriver 3 4 5,5 6,5 8 mm Phillips screwdriver PH 1 2 Phillips screwdriver PZ 1 2 VDE slotted screwdriver 2,5 mm VDE Phillips screwdriver PH 1 Phase tester 3 mm	0.927





**R38920000**

**EXTENDABLE SHANK SCREWDRIVER**

13 IN 1

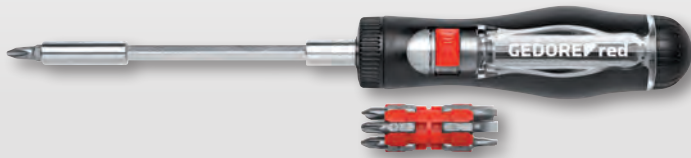
- > 13 Screwdriver profiles in magazine
- > Screwdriver handle with integrated ratchet function, reversible
- > Hex recess drive as per DIN 3126 - D 6.3 (1/4"), for bits
- > Lockable telescopic blade, continuously adjustable
- > Reversible clockwise/anticlockwise ratchet function



Code	No.	□"	□	Contents	 mm	Weight Kg
3301337	R38920000	1/4"	6,3	Magazine screwdriver with 1/4" bits Slot 4,4,5 5,5 mm Cross recess PH 1 2 3 Cross recess PZ 1 2 TX T10 T15 T20 T25 Inside hexagon 4 mm	128	0.280

**R33005031**  
**BIT BOX 1/4"**

32 pieces

- > Bits: Hardness: 60 HRC +/- 2, torque: 18.4 N-m
- > Drive adaptor with magnetic bit locking
- > Hexagon drive according to DIN 3126 ISO 1173 - C 6.3
- > Machine-operated
- > Box with clear cover



WHILE STOCKS LAST



Code	No.	Contents	Weight Kg
3301338	R33005031	1/4" hexagon sizes 3 4 5 1/4" slotted 0.6x4.5 1.0x5.5 1.2x6.5 2x 1/4" cross-head PH 1 2 3 2x 1/4" cross-head PZ 1 2 3 2xTX T10 T15 T20 T25 T30 T40 Quick change adaptor for 1/4" bits C 6.3 with magnet Bit adaptor 1/4" hex x 1/4" square	0.250

**R38672006**  
**2CT HANDLE**  
**CRANKED**  
**SOCKET KEY**  
**SET**

in hex, 6 pieces

- > Two-way profile
- > 2-component-handle for a hands-friendly transfer of force

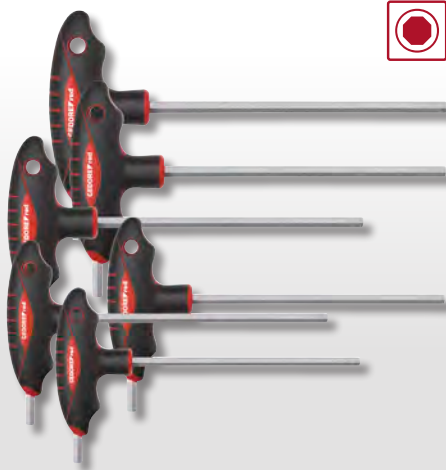

Code	No.	Contents	Pieces	Weight Kg
3301281	R38672006	SW 2,5 3 4 5 6 8 mm	6	0.731

**R38402006**  
**TX SCREWDRIVER**  
**SET**

6 pieces

- > Blade of high-grade chrome-molybdenum steel, chrome-plated
- > Moulded handle forms a firm unit with the blade
- > 5-edge handle head stops it rolling off when put down



Code	No.	Contents	Pieces	Weight Kg
3301272	R38402006	TX screwdriver T10 T15 T20 T25 T30 T40	6	0.55



**R36605009**  
ALLEN KEY SET

in hex, 9 pieces



> In a plastic holder



Code	No.	Contents	Pieces	Weight Kg
3301331	R36605009	Hexagon allen key 1,5 2,2,5 3 4 5 6 8 10	9	0.250

**R36675009**  
ALLEN KEY SET

in hex, 9 pieces



> With ball end  
> In a plastic holder



Code	No.	Contents	Pieces	Weight Kg
3301335	R36675009	Size 1.5 2.2.5 3 4 5 6 8 10	9	0.404

**R36601009**

**ALLEN KEY SET WITH COLOUR CODING, HEX**

9 pieces, long

- > Colour coded plastic coating to find the right L-key faster
- > Round shape
- > Long version with ball end
- > Folding holder with belt clip

Hexagon socket  
wit ball end

Colour coded

**NEW**



Folding holder

Code	No.	Contents	Pieces	Weight Kg
3301332	R36601009	1.5 2.2.5 3 4 5 6 8 10 mm	9	0,600

# PLIERS



## ERGONOMOMIC POWER PACKS

### i

#### GRIPPING, HOLDING, CUTTING AND PRESSING

- Optimised gripping surfaces combined with high cutting performance ensure the best possible work results
- Virtually loss-free power transmission from the handle via the joint to the workpiece
- Easy adjustment and operation - even in the case of large pipe and water pump pliers

**R2830XXXX**  
COMBINATION  
PLIERS



- > Acc. to DIN ISO 5746
- > With gripping zones for flat and round stock
- > Induction-hardened cutting edges
- > 2-component-handle for a hands-friendly transfer of force
- > Chrome-vanadium steel

> **1000V Insulated plastic handle**



Code	No.	l-mm	Hard wire Ø mm	Weight
3301124	R28302180	180	1,6	0.240
3301125	R28302200	200	1,8	0.305

**R2842XXXX**  
POWER SIDE  
CUTTERS



- > Acc. to DIN ISO 5749
- > High cutting performance with low force
- > Slim head
- > Induction-hardened long cutting edges
- > 2-component-handle for a hands-friendly transfer of force
- > Chrome-vanadium steel

> **1000V Insulated plastic handle**



Code	No.	l-mm	Piano wire Ø mm	Weight
3301127	R28422180	160	1,8	0.23
3301128	R28422200	185	2,0	0.32

**R2850XXXX**  
TELEPHONE  
PLIERS



- straight
- > Acc. to DIN ISO 5745
  - > Straight grip surfaces, lengthways-serrated
  - > Induction-hardened cutting edges
  - > 2-component-handle for a hands-friendly transfer of force
  - > Chrome-vanadium steel

> **1000V Insulated plastic handle**



Code	No.	l-mm	Hard wire Ø mm	Weight
3301133	R28502200	165	1,8	0.200

**R28001004**  
PLIERS SET

3 pieces

- > High-frequency, heat treated induction hardened cutting edges:  
Main body : 42-48HRC  
Cutting edge: 53-60HRC
- > 2-component-handle for a hands-friendly transfer of force
- > Chrome-vanadium steel
- > Blister packed

- > **Cutting Capacity:**  
Telephone Pliers: 1.6mm diameter  
Side Cutters: 1.8mm diameter  
Combination Pliers: 2.0mm diameter
- > Material: 50CrV steel/Chrome-vanadium steel

> **1000V Insulated plastic handle**



Code	No.	Contents	Pieces	Weight Kg
3301189	R28002003	Combination pliers 200 mm Side cutter 185 mm Telephone pliers, straight 165 mm	3	0.711

**NEW**

**R28002200**

# MULTI-SIDE CUTTER

- › Side cutter with multiple functions – suitable for cutting, gripping, and holding
- › Cutting capacity up to 2 mm wire diameter – ideal for soft and medium wires
- › Crimping possible for conductor cross-sections from 0.75 – 1.5 mm<sup>2</sup> and 1.5 – 2.5 mm<sup>2</sup>
- › Stripping area for insulation diameters from 1 – 2.6 mm – precise cable stripping
- › 2-component grip with non-slip surface – secure hold and fatigue-free work

**Combined functions for versatile use**



**Ergonomic 2-component handles**

**Additional crimp functionality**

**Suitable for various types of wires**

Code	No.	Total length mm	Weight Kg
3301912	R28002200	200	0,309

## R27604060 CIRCLIP PLIERS EXTERNAL

straight

- › Acc. to DIN 5254 Form A
- › Straight precision tips
- › With opening spring
- › DIN 471 for retaining rings
- › DIN 983 for shaft diameter
- › Dip-coated handle covers
- › Chrome-vanadium steel

WHILE STOCKS LAST



Code	No.	Size	Tip-Ø	Ring-Ø	Weight Kg
3301138	R27604060	A2	1,8	19	0.180

## R27654060 CIRCLIP PLIERS EXTERNAL

angled

- › Acc. to DIN 5254 Form B
- › 90° angled precision tips
- › With opening spring
- › DIN 471 for retaining rings
- › DIN 983 for shaft diameter
- › Dip-coated handle covers
- › Chrome-vanadium steel

WHILE STOCKS LAST



Code	No.	Size	Tip-Ø	Ring-Ø	Weight Kg
3301141	R27654060	A11	1,8	19	0.160

**R27704060**  
CIRCLIP PLIERS  
INTERNAL

straight

- > Acc. to DIN 5256 Form C
- > Straight precision tips
- > DIN 472 for retaining rings
- > DIN 984 for drill hole diameter
- > Dip-coated handle covers
- > Chrome-vanadium steel

WHILE STOCKS LAST



Code	No.	Size	Tip-Ø	Ring-Ø	Weight Kg
3301144	R27704060	J2	1,8	19	0.150

**R27754060**  
CIRCLIP PLIERS  
INTERNAL

angled

- > Acc. to DIN 5256 Form D
- > 90° angled precision tips
- > DIN 472 for retaining rings
- > DIN 984 for drill hole diameter
- > Dip-coated handle covers
- > Chrome-vanadium steel

WHILE STOCKS LAST



Code	No.	Size	Tip-Ø	Ring-Ø	Weight Kg
3301147	R27754060	J21	1,8	19	0.150

**R28002004**  
CIRCLIP PLIERS SET

straight and angled,  
4 pieces

- > Circlip pliers for external retaining rings, straight and angled, Size 2
- > Circlip pliers for internal retaining rings, straight and angled, Size 2
- > Dip-coated handle covers
- > Chrome-vanadium steel

WHILE STOCKS LAST



Code	No.	Contents	Pieces	Weight Kg
3301156	R28002004	External fuse tongs straight A2 External fuse tongs angled A21 Internal fuse clamp straight J2 Internal fuse tongs angled J21	4	0.680

**R28924110**  
TOWER PINCER

- > Acc. to DIN ISO 9242
- > Head polished
- > Pliers for heavy-duty use
- > Induction-hardened cutting edges
- > Dip-coated handle covers
- > Special tool steel, forged

WHILE STOCKS LAST



Code	No.	↳ mm ▷	Medium-hard wire Ø mm	Weight Kg
3301842	R28924110	250	2,4	0.395

**R2720XXXX**  
GRIP WRENCH

- > For clamping and gripping profiled, round and flat-section material
- > Lengthways-serrated grip surfaces
- > With adjusting screw and release lever
- > One-handed operation
- > Chrome-plated surface
- > Chrome-vanadium steel



Code	No.	↳ mm ▷	↳ inch ▷	mm Ⓢ	Weight Kg
3301177	R27200007	185	7	35	0.375
3301178	R27200010	225	10	40	0.545

**R2716XXXX**  
PIPE WRENCH

American pattern

- > Stillson type
- > Hardened knurled nut fixes span width
- > With hanging hole
- > Forged steel



Code	No.	mm	inch	mm	inch	Weight Kg
3301204	R27160009	250	10	43	1.7/8	0.800
3301205	R27160011	300	12	53	2.1/8	1.000
3301207	R27160016	450	18	76	3	2.100

**R2710XXXX**  
PIPE WRENCH

Swedish pattern

- > Acc. to DIN 5234
- > Heavy-duty pattern
- > Mouth position 90° angled
- > Teeth offset against direction of rotation
- > Jaws polished
- > Captive adjusting nut
- > Chrome-vanadium steel



Code	No.	inch	mm	mm	Weight Kg
3301157	R27100010	1	40	320	0.780
3301158	R27100015	1.1/2	55	420	1.356
3301159	R27100020	2	67	555	2.550

**R28902205**

**CRIMPING PLIERS**

**NEW**

- > Suitable for cross-sections of 2.5 / 4.0 / 6.0 mm<sup>2</sup> – specially for MC4® connectors
- > Easy handling
- > Ergonomics: High crimping force due to efficient lever transmission; ergonomically shaped handles with multi-component sleeves for comfortable handling

Efficient power transmission and comfort



High crimping force

Ergonomically shaped handles

Optimized for PV-specific cross-sections

Code	No.	Capacity mm <sup>2</sup>	Total length mm	Total width mm	Weight Kg
3301903	R28902205	2,5 mm <sup>2</sup> 4,0 mm <sup>2</sup> 6,0 mm <sup>2</sup>	204	68	0,391

**R28154010**  
**WATER PUMP PLIERS WITH AUTOMATIC ONE HAND ADJUSTMENT**

- > Acc. to DIN 8976
- > Automatic setting mechanism for one-handed operation
- > Safety-box joint, substantial stability from a double guide
- > Slim design allows good access to the workpiece
- > Lengthways-serrated grip surfaces
- > head polished
- > Dip-coated handle covers
- > Chrome-vanadium steel



Code	No.	◀ mm ▶	mm	Weight Kg
3301172	R28154010	250	35	0.374

**R2810XXXX**  
**WATER PUMP PLIERS**

7 settings

- > Acc. to DIN 8976 Form C
- > Lengthways-serrated grip surfaces
- > With box joint
- > 7 settings
- > head and knuckle brightly ground
- > Chrome-vanadium steel
- > Red powder-coated



Code	No.	◀ mm ▶	mm	Weight Kg
3301175	R28100010	250	33	0.300

**R28904260**

**HAND RIVETER**

- > Interchangeable nozzle bushings fit right on the gun
- > Spring loaded handle for automatic ejection of mandrel
- > Smooth, easy, one-handed operation
- > Contour grip handle with vinyl cover for added comfort



Blister packed

Four sizes



**NEW**

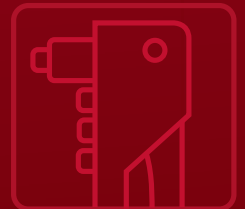

**Size x4**

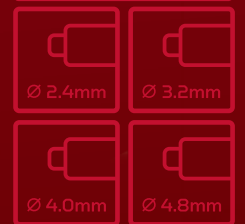

Code	No.	Total length mm	Rivet-Ø	Weight Kg
3301845	R28904260	260	2.4 3.2 4.0 4.8mm	0.620

# STRIKING TOOLS

*TOUGH  
FELLOWS*



## CONCENTRATED USE OF POWER

- Forged, robust hammer heads with induction-hardened striking surfaces
- Secure connections between head and handle for long service life and improved safety at work
- Chisels, centre punches and drivers with tempered striking ends are particularly robust

### R9220XXXX CLUB HAMMER

- > Drop-forged hammer head, black paint-finished, of heat-treated steel
- > Striking surface inductively case-hardened for tough long-term work
- > 360° clamping force of the tapered collar fixes the hammer head



Code	No.	g	l-mm	Weight Kg
3300726	R92200050	1250	260	1.350
3300728	R92200065	2000	300	2.110

### R9216XXXX BALL PEIN HAMMER

with hickory handle

- > Drop-forged hammer head of heat-treated steel
- > Carefully ground track and ball
- > Double-curved hickory handle
- > 360° clamping force of the tapered collar fixes the hammer head



Code	No.	g	l-mm	Weight Kg	Code	No.	g	l-mm	Weight Kg
3300766	R92160002	113	255	0.176	3300769	R92160005	453	330	0.640
3300767	R92160003	227	290	0.340	3300770	R92160008	680	350	0.920
3300768	R92160004	340	310	0.470	3300771	R92160010	907	390	1.060

### R9128XXXX BALL PEIN HAMMER

with fibreglass handle

- > Forged type from special steel
- > Fibreglass handle



Code	No.	g	l-mm	Weight Kg	Code	No.	g	l-mm	Weight Kg
3300761	R9128400280	200	315	0.450	3300764	R9128400287	700	345	1.00
3300762	R9128400282	300	320	0.650	3300765	R9128400300	1000	380	1.250
3300763	R9128400284	500	340	0.850					

### R92420023 CLAW HAMMER

American pattern

- > Forged type from special steel
- > Pein with nail extractor
- > track and tiller brightly ground
- > Rounded edges



Code	No.	Ø mm	g	oz	lbs	l-mm	Weight Kg
3300782	R92420023	27	570	20	1.1/4 lbs	340	0.840

### R90200006 PIN PUNCH SET

6 pieces

- > Tempered striking ends
- > Made from chrome-vanadium steel



Code	No.	Contents	Weight Kg
3300823	R90200006	Splinter driver Ø 3 4 5 6 7 8 mm	0.800

### R90100006 DRIFT PUNCH SET

6 pieces



Code	No.	Contents	Weight Kg
3300825	R90100006	Punches Ø 1 2 3 5 10 mm punch Ø 4 mm	0.720

### R90000006 CHISEL AND PUNCH SET

6 pieces



Code	No.	Contents	Weight Kg
3300826	R90000006	Flat cold chisel- length 125 mm 150 mm Cross-cut chisel- length 125 mm Drift punch - Ø 3 mm Centre punch - Ø 4 mm Pin punch - Ø 4 mm	0.760



# MEASURING



## PRECISE ASSISTANTS



### ACCURATE TO THE MILLIMETRE

- Easy-to-read and precise spirit levels, rulers and tape measures
- Practical additional functions for even easier and more accurate measuring and marking
- Digital measuring caliper - the solution for fast, uncomplicated, precise measurement, reading and transferring values

## R9455XXXX TAPE MEASURE

- > Housing from 2-component ABS, fitted out with metal clip
- > Automatic tape rewind and lock
- > With magnetic stop
- > Accuracy class II with MID certificate



Code	No.	L m	mm	Weight Kg
3301427	R94550003	3	19	0.201
3301428	R94550005	5	19	0.265
3301429	R94550008	8	25	0.468



## R94420021 DIGITAL MEASURING CALIPER

- > Large LCD display 30 x 10 mm, with automatic switch-off
- > Resetting possible at any position
- > With mm/inch switching
- > With crossbill
- > Connection to PC interface
- > Measured value fixation by locking screw

WHILE STOCKS LAST



Code	No.	mm	Weight Kg
3301430	R94420021	153	0.340

# CUTTING, FILING



*VERSATILE  
HELPERS*

**i**

## **CUTTING, SAWING, FILING, AND MORE**

- Versatile range of large and small workshop helpers
- High-quality materials and robust designs

### R93210000 HEAVY-DUTY UTILITY KNIFE



- > Aluminium housing
- > Quick change mechanism of the blade
- > For right and left-handers
- > Supplied with one trapezoid blade and 4 spare trapezoid blades in cartridge



Code	No.	Designation		Weight Kg
3301598	R93210000	Heavy-duty utility knife	365	0.31

### R93200010 UTILITY KNIFE



- > Blade 9 mm wide
- > Supplied with 5 spare blades (80mm long, 0.4mm thick)

WHILE STOCKS LAST



Code	No.	Designation		mm	mm	Weight Kg
3301601	R93200010	Utility knife small with 5 blades 10 mm	145	9		0.068

### R93250008 POCKET KNIFE



- > Blade locking feature
- > Two-handed operation
- > Secure in pocket and on belt; cannot be accidentally opened
- > With sawing function for fibrous materials eg. ropes and textiles



Code	No.			Weight Kg
3301615	R93250008	87	210	0.154

### R93310041 IDEAL PATTERN SNIPS

- > Self-opening with installed spring, with lock
- > Induction-hardened precision cutting edges
- > 2-component-handle for a hands-friendly transfer of force
- > for stainless steel sheet up to 0,8 mm

WHILE STOCKS LAST



Code	No.	Size	Version	Cutting edge length	Total length	Weight Kg
3301741	R93310041	10	Right hand cutting	30	245	0.41

### R93200023

## SAFETY KNIFE

- > Premium safety knife for professional industrial and logistics applications
- > Fully automatic blade retraction technology for maximum cut protection
- > Ergonomic aluminum handle body for high stability and comfortable handling
- > Extra-long cutting depth – ideal for cardboard, film, strapping, paper rolls, and much more
- > Ambidextrous slider – perfect for both left- and right-handed users
- > Tool-free blade change for quick and efficient workflow
- > Robust, durable construction for demanding continuous use
- > High cutting force combined with excellent safety
- > Non-slip grip zones for precise and comfortable work
- > Compatible with various industrial blades for flexible applications

Fully automatic  
blade retraction



Maximum  
user safety

**NEW**

Compatible  
with standard  
trapezoid blades

Ergonomic plastic  
handle body

Code	No.	Total length mm	Weight kg
3301963	R93200023	189	0.136

R93350300

# HACKSAW



Heavy-duty  
steel frame

Aluminium  
handle



Wing nut &  
lever blade  
tensioning  
system to  
adjust the  
blade

Bi-metal  
blade 24 TPI

Blade can be  
set at 90 or  
45 degrees

Code	No.	Total Length mm	Blade mm
3301732	R93350300	402	300

## R93350021 HACKSAW

- › Made of aluminium
- › Saw blade for different materials
- › Easy to tension and adjust



Code	No.	Designation	Weight Kg
3301609	R93350021	Small saw	0.22
3301610	R93990021	Saw blade	0.012

## R9310XXXX FILES

- › 2-component-handle for a hands-friendly transfer of force



Code	No.	Designation	Slash	mm	mm	Weight Kg
3301591	R93100052	Triangular file	2	200	310	0.195
3301592	R93120052	Flat file	2	200	310	0.192
3301593	R93140052	Round file	2	200	310	0.124
3301594	R93160052	Half-round file	2	200	310	0.21
3301595	R93180052	Square file	2	200	310	0.124

## R93000005 FILE SET

- › 2-component-handle, for easy handling
- › Made of special steel
- › In plastic bag



Code	No.	Contents	Pieces	Weight Kg
3301597	R93000005	Triangular file Flat file Square file	Round file Half-round file	5 0.82

## R93000006 KEY FILE SET

- › With wooden handle
- › Made of special steel



Code	No.	Contents	Pieces	Weight Kg
3301596	R93000006	Triangular file Flat file Round file	Half-round file Square file	6 0.85

### R93800125 VICE



- > Vise opening to the front
- > With anvil
- > Max. clamping force 25 KN



Code	No.	Version	mm	Weight Kg
3301737	R93800125	fix	125	19.000

### R93600022 SMALL TUBE CUTTER

- > For copper pipes 3-22 mm
- > With 2 supporting rollers
- > Metal housing
- > With knurled adjusting wheel

WHILE STOCKS LAST



Code	No.	Size	Ø mm	↳ mm	Weight Kg
3301616	R93600022	1/8-7/8	3-22	60	0.14

### R99210000 CARTRIDGE CAULKING GUN

- > For processing silicon, packed in bag or cartridge form, for 310 ml contents
- > With stable aluminium tube
- > Quick and easy cartridge change
- > Supplied with 3 tips



Code	No.	L	H	Weight Kg
3301753	R99210000	340	210	0.84

### R93400060 SCRAPER

- > For minor improvements/repair
- > Apply, spread and smooth down
- > With wooden handle

WHILE STOCKS LAST



Code	No.	Blade width	Weight Kg
3301754	R93400060	60,0	0.1

### R95300017 LED TORCH

- > 2 levels of brightness plus warning/signal function
- > 1 W LED
- > Luminous flux 55-60 lm
- > Light range 25-30 m



Code	No.	L	Weight Kg
3301755	R95300017	130	0.156

### R99800000 MULTIFUNCTION TOOL 13 IN 1

- > Stainless steel
- > Blade locking feature
- > Ergonomic handle, gentle power transmission



Code	No.	Weight Kg
3301757	R99800000	0.21

# 1000 VOLT

UNCOMPROMISING  
PROTECTION



**i**

#### ON THE SAFE SIDE

- Extensive range of VDE-insulated tools
- Tools VDE-insulated according to DIN EN 60900
- Guaranteed protection while working under voltage up to 1000V AC (alternating voltage) and 1500V DC (direct voltage)

### R2930XXXX VDE COMBINATION PLIERS

- > Acc. to DIN ISO 5746
- > Complies with VDE 0682 Part 201 and EN/IEC 60900
- > With gripping zones for flat and round stock



WHILE STOCKS LAST



Code	No.	↳ mm ↳	Cutting power (max.)	Weight Kg
<b>3301408</b>	R29300180	180	1,6	0.275
<b>3301409</b>	R29300200	200	1,8	0.360

### R29400180 VDE POWER SIDE CUTTERS

- > Acc. to DIN ISO 5749
- > Complies with VDE 0682 Part 201 and EN/IEC 60900
- > Slim head



WHILE STOCKS LAST



Code	No.	↳ mm ↳	Cutting power (max.)	Weight Kg
<b>3301411</b>	R29500200	200	1,8	0.260

### R29500200 VDE TELEPHONE PLIERS straight

- > Acc. to DIN ISO 5745
- > Complies with VDE 0682 Part 201 and EN/IEC 60900
- > Straight grip surfaces, lengthways-serrated



Code	No.	↳ mm ↳	Cutting power (max.)	Weight Kg
<b>3301410</b>	R29400180	180	1,6	0.280

### R29510200 VDE TELEPHONE PLIERS bent

- > Acc. to DIN ISO 5746
- > Complies with VDE 0682 Part 201 and EN/IEC 60900
- > 45° angled grip surfaces, lengthways-serrated



WHILE STOCKS LAST



Code	No.	↳ mm ↳	Cutting power (max.)	Weight Kg
<b>3301412</b>	R29510200	175	1,8	0.260

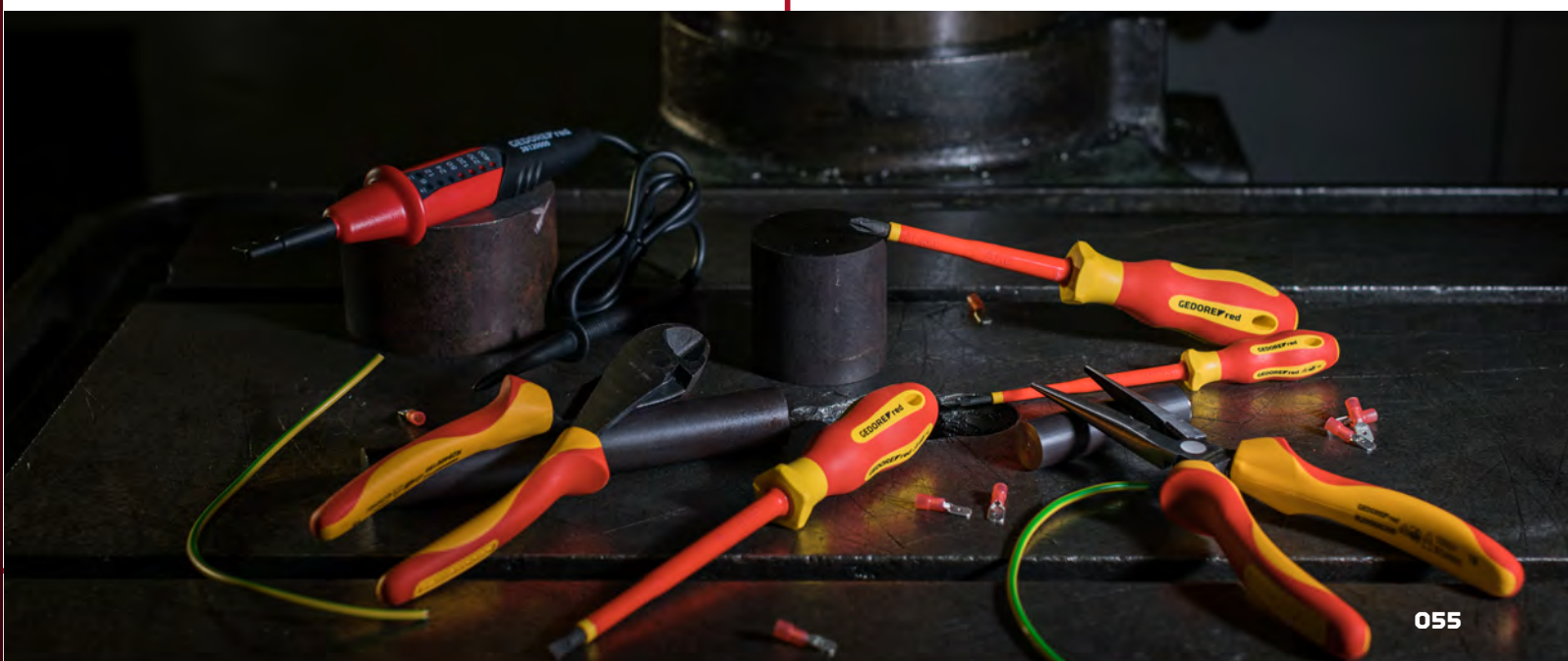

**NEW**

**R3900**2020

# VDE INTERCHANGEABLE BLADE SET

20 pieces

- › 20-piece VDE interchangeable blade screwdriver set – ideal for electrical and installation work
- › S2 steel “Slim” blades for precise work even in tight or deep areas
- › Includes 16 blades for versatile applications
- › Two ergonomic handles for comfortable and controlled work
- › Supplied in a robust pouch – ideal for mobile use and clean storage
- › Lightweight, compact, and perfectly organized for professional use

Guaranteed  
electrical safety



Robust  
pouch

Several screwdrivers  
in one compact set

Practical color coding for quick  
identification of the right blade

Code	No.	Length mm	Width mm	Height mm	Pieces	Weight kg
3301961	R39002020	215	100	65	20	0,622

**Contents**

2x VDE screwdriver handle, 1x triangular key, 1x square key  
5x slotted 1.2 × 6.5 1.0 × 5.5 0.8 × 4.0 0.6 × 3.5 0.5 × 3.0 | 100 mm  
2x Phillips PH2 × 100 mm PH1 × 80 mm

2x Pozidriv PZ2 × 100 mm PZ1 × 80 mm 3x TX T20 T15 T10 | 100 mm  
2x PlusMinus slotted/Phillips SL/PH2 × 100 mm SL/PH1 × 80 mm  
2x PlusMinus slotted/Pozidriv SL/PZ2 × 100 mm SL/PZ1 × 80 mm

**R93220028**  
VDE CABLE KNIFE



bent

- > VDE-insulated acc. to DIN EN 60900
- > with fixed, sturdy blade with straight cutter and protective cap
- > Straight cutting edge
- > With protective cap



Code	No.			Weight Kg
3301415	R93220028	45	185	0.143

**R39002005**

VDE SET

5 pieces

**VDE screwdriver:**

- > For slotted head screws: According to DIN 5264, DIN ISO 2380
- > For cross-head screws PH: According to DIN 7438, DIN ISO 8764

> **VDE Side cutter:**

- > According to DIN ISO 5749

**VDE Telephone pliers, straight:**

- > According to DIN ISO 5745

WHILE STOCKS LAST



Code	No.	Contents	Weight Kg
3301414	R39002005	VDE Screwdriver slotted 3, 5.5 mm VDE Screwdriver cross-slotted PH 2 VDE Side cutter 180 mm VDE Telephone pliers 200 mm, straight pattern	0.833



# AUTOMOTIVE

## CLEVER AUTOMOTIVE ASSISTANTS



### SPECIAL TOOLS FOR MECHANICS

- Tools for steering and steering geometry, engines, gearboxes, bodywork and interior fittings
- Tool sets especially for the automotive sector

### R15151000 HOSE CLAMP PLIERS SET

3 pieces

- > For disconnecting flexible hose lines
- > Adjustable locking device with latching function
- > Temperature resistant up to 160°



Code	No.	Tong lengths	for diameter	Weight Kg
3301539	R15151000	160 mm 185 mm 225 mm	Ø up to approx. 60 mm	0.298

### R15551000 OIL FILTER SPANNER



- > For safe, rapid unscrewing of oil filters
- > Continuously adjustable, hand-operated
- > Drive 1/2" according to DIN 3120 - C 12.5, ISO 1174, and SW 19 mm
- > Holding segments stop any slipping



Code	No.	Version	Weight Kg
3301540	R15551000	65 - 120 mm Ø	0.315

### R15551001 OIL FILTER STRAP-WRENCH



- > For safe, rapid unscrewing of oil filters
- > Continuous adjustment of the filter belt
- > 1/2" Drive (12,5 mm)
- > Hand-operated

WHILE STOCKS LAST



Code	No.	Ø mm	↳ mm ‹	Weight Kg
3301541	R15551001	152	150	0.240

### R19101001 HOOK SET

4 pieces

- > Assembly/disassembly of O-rings, seals in the areas of engine, transmission, steering and hydraulic systems
- > For work on the car body interior

WHILE STOCKS LAST



Code	No.	Weight Kg
3301548	R19101001	0.114

**NEW**

R99200001

# MAGNETIC LIFTER

- › 4-prong claw grabber: Allows secure gripping and holding of small objects in hard-to-reach areas
- › Integrated LED lighting: Provides optimal visibility in dark or poorly lit work areas
- › Flexible shaft: Flexible design allows access to objects in narrow or angled spaces
- › Magnetic tip: Ideal for picking up metallic small parts such as screws or nuts
- › Ergonomic handle: Provides comfortable grip and precise control when grabbing
- › Versatile applications: Suitable for workshops, households, plumbing, and automotive applications

LED illumination

Long reach and flexibility

Ergonomic handle



Precise gripping of various object sizes



Code	No.	Total length mm	Weight Kg
3301927	R99200001	720	0,134

## R19102000 MAGNETIC TRAY



- › Secure storage of small metal parts
- › Stainless steel
- › 2 extra strong rubber-protected magnets



Code	No.	L	H	W	Weight Kg
3301547	R19102000	240	46	140	0.744

## R01701723 WHEEL SPANNER

- › Chrome-vanadium steel
- › Chrome plated



Code	No.	mm	mm	Weight Kg
3301537	R01701723	17 x 19 x 21 x 23	360	1.250

**NEW**

R18201001

# PLASTIC STAPLE REMOVER

24x6 M

- > Nickel plated finish
- > 30 degree tilt angle
- > Two-level opening for easy fitting
- > Special GEDORE red steel rod
- > Polypropylene injected handle
- > Blister packed for attractive display



30° tilt angle

nickle plated

Code	No.	Description	Total length mm	Total width mm	Total height mm	Weight Kg
3301846	R18201001	Plastic Staple Remover 24x6mm	307	94	30	0,155





# ENGINE TOOLS VAG

**NEW**



**R15003003**

## ENGINE TIMING TOOL SET, VAG

(1.0 / 1.2 / 1.4 / 1.5 TSI/TFSI)

- > Special tool set for precise positioning of the camshafts and locking of the flywheel and timing belt pulley on the auxiliary drive
- > Indispensable for professional timing adjustment when changing timing belts or repairing engines
- > Ideal for modern EA211 engines with or without ACT (Active Cylinder Technology) cylinder deactivation
- > Intuitive measuring system with highly sensitive angle gauge for camshaft positioning
- > Correctly positioned camshafts in these engines are crucial for fault-free running and compliance with the strict exhaust emission limits
- > No additional OBD interactions with the vehicle or other complex diagnostic technology required
- > Cost-effective and practical alternative solution to the OEM tool VAS 611 007

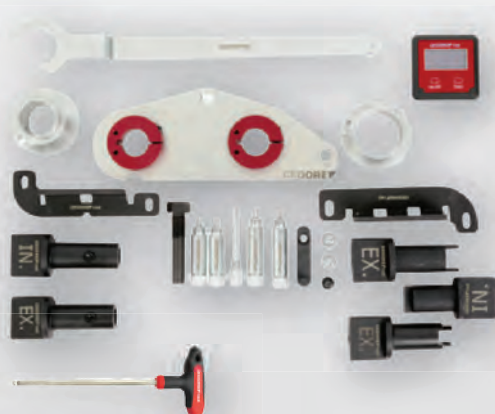

**DIMENSIONS mm: Length: 470 Width: 330 Height: 100**

Code	No.	OE Reference Number	Engine Codes	Weight Kg
3301780	R15003003	VAS 611 007, T10340, T10499, T10504/1		6.100

**NEW**

**R15003006**

# ENGINE TIMING TOOL SET, VAG

(1.0 / 1.2 / 1.4 TSI/TFSI)

- > Tool set for locking the intake and exhaust camshaft, flywheel and positioning the timing belt tensioner
- > Indispensable for professional timing adjustment when changing timing belts or repairing engines



**DIMENSIONS mm: Length: 470 Width: 330 Height: 100**

Code	No.	OE Reference Number	Engine Codes	Weight Kg
3301783	R15003006	T10060 A, T10340, T10476, T10476 A, T10477, T10487, T10494, T10499, T10504, T10504/1, T10504/2		3.800

**R15003013**

# CAMSHAFT HOLDING TOOL, VAG

- > Tool set for counter-holding of toothed belts and timing chain sprockets
- > Essential for the professional loosening and tightening of timing belt and chain sprockets
- > Includes 11 different bolt/adaptor pairs and an adapter for EA211 camshaft phaser (VVT)



**DIMENSIONS mm: Length: 470 Width: 330 Height: 100**

**NEW**

Code	No.	OE Reference Number	Engine Codes	Weight Kg
3301947	R15003013	T10172, T10172A, T10172/10, T10172/9, T10172/4, T10172/11, T10172/5, T10172/6, T10172/7, T10172/8, T10172/1, T10172/2, T10554		3.700



# ENGINE TOOLS BMW

**NEW**

**R15003016**

## ENGINE TIMING TOOL SET, BMW

B38 / B46 / B48

- › Tool set for locking the camshafts and flywheel, pre-tensioning the timing chain tensioner, and checking the settings of the camshaft sensor wheels
- › Essential for changing the timing chain, removing and installing the VANOS adjustment units, or repairing the engine



**DIMENSIONS mm:** Length: 470 Width: 330 Height: 100

Code	No.	OE Reference Number	Engine Codes	Weight Kg
<b>3301950</b>	R15003016	2 358 122, 2 228 380, 2 365 488, 11 8 580, 11 9 340, 11 6 480, 2 360 895		7.500

**NEW**

**R15003020**

# ENGINE TIMING TOOL SET, BMW

N12 / N14 / N16

- > Tool set for locking the camshafts and crankshaft, pre-tensioning the timing chain tensioner, and adjusting the VANOS adjustment units
- > Essential for changing the timing chain, or repairing the engine

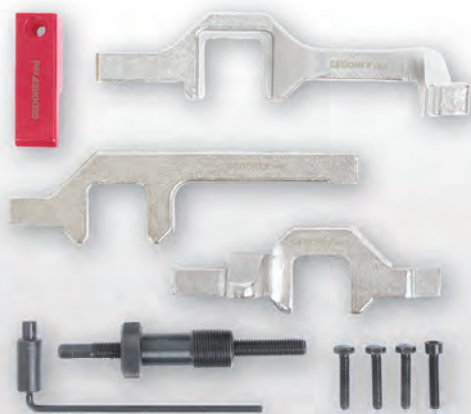

**DIMENSIONS mm: Length: 490 Width: 340 Height: 135**

Code	No.	OE Reference Number	Engine Codes	Weight Kg
3301954	R15003020	119 590, 119 540, 119 550, 119 551, 119 552, 119 340		4.000



**R15003021**

# ENGINE TIMING TOOL SET, BMW

N20 / N26

- > Tool set for locking the camshafts and flywheel, pre-tensioning the timing chain tensioner, and checking the settings of the camshaft sensor wheels
- > Essential for changing the timing chain, or repairing the engine

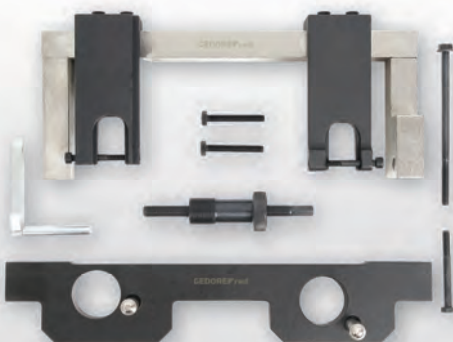

**DIMENSIONS mm: Length: 470 Width: 300 Height: 100**

Code	No.	OE Reference Number	Engine Codes	Weight Kg
3301955	R15003021	83 30 2 212 831, 2 219 548, 83 30 2 212 830, 11 9 340		4.300



**NEW**



**NEW**

**ENGINE TOOLS**

**MERCEDES-BENZ**

**R15003018**

**ENGINE TIMING TOOL SET,  
MERCEDDES-BENZ**

M270 / M274 / M133

- > Tool set for locking the camshafts on engines with and without CAMTRONIC
- > Includes sockets for rotating the camshafts
- > Essential for changing the timing chain, or repairing the engine



**DIMENSIONS mm: Length: 304 Width: 222 Height: 80**

Code	No.	OE Reference Number	Engine Codes	Weight Kg
3301952	R15003018	270 589 01 61 00, 271 589 00 10 00, 270 589 01 07 00		4.200

**NEW**

**R15003022**

# ENGINE TIMING TOOL SET, MERCEDES-BENZ

M271

- > Tool set for locking the camshafts during timing chain replacement
- > Includes timing chain installation aid, punch for sealing plug, tensioner relief wedge, and socket
- > Essential for changing the timing chain, or repairing the engine



**DIMENSIONS mm: Length: 390 Width: 295 Height: 90**

Code	No.	OE Reference Number	Engine Codes	Weight Kg
3301956	R15003022	271 589 01 40 00, 271 589 00 61 00, 271 589 00 31 00, 271 589 00 15 00, 271 589 00 10 00		3.200



**R15003023**

# ENGINE TIMING TOOL SET, MERCEDES-BENZ

OM651

- > Tool set for locking the camshafts during timing chain replacement
- > Includes timing chain installation aid, crankshaft holding tool and camshaft socket
- > Essential for changing the timing chain, or repairing the engine



**DIMENSIONS mm: Length: 304 Width: 222 Height: 80**

Code	No.	OE Reference Number	Engine Codes	Weight Kg
3301957	R15003023	651 589 00 40 00, 651 589 01 40 00, 651 589 09 40 00, 651 589 03 40 00		3.300



**NEW**

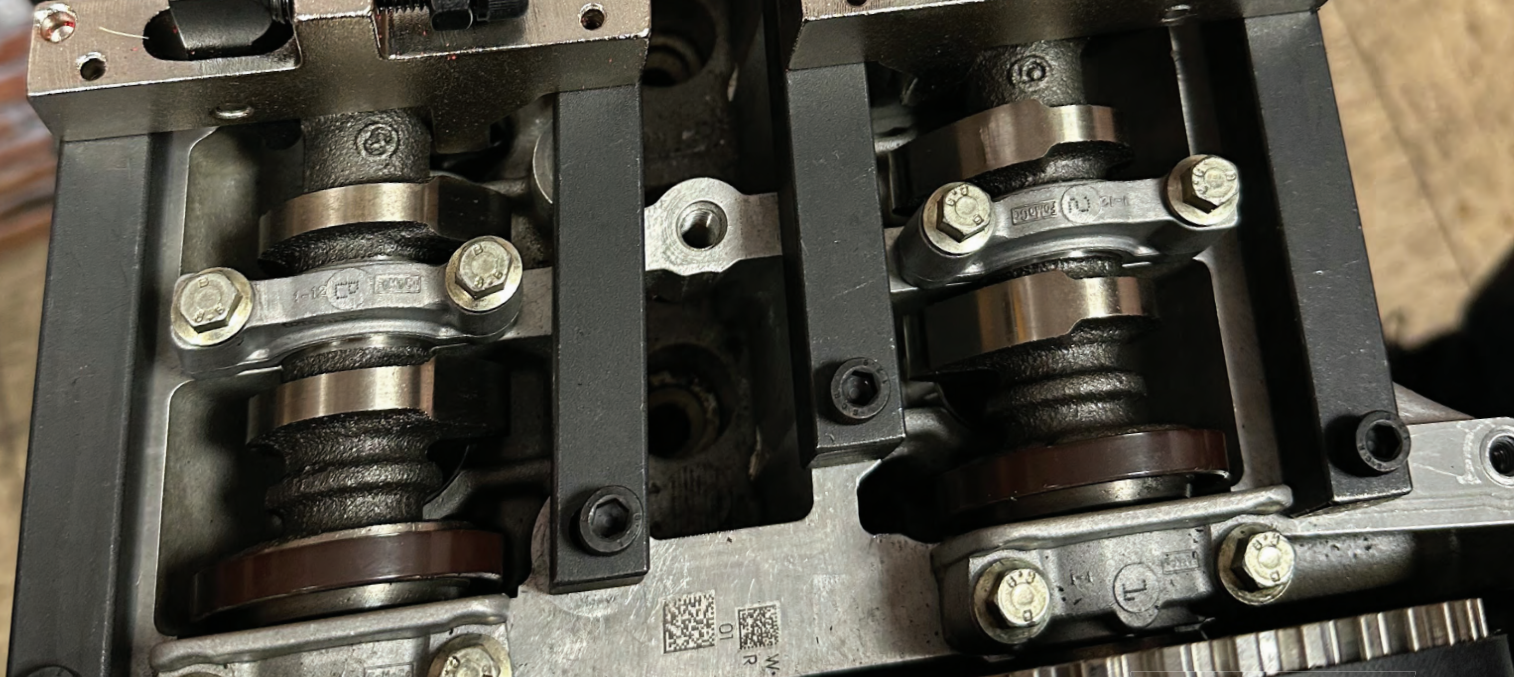

# ENGINE TOOLS FORD

**NEW**

**R15003000**

## ENGINE TIMING TOOL SET, FORD

1.0 / 1.1 EcoBoost

- > Comprehensive locking tool kit, incl. pressing tool for crank shaft sealing ring
- > For professional locking and adjusting the timing
- > Required when replacing the toothed belt or when repairing the engine
- > Recommended accessories: Torque multiplier R15003001 from GEDORE red

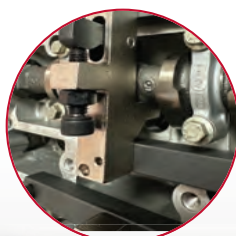

**DIMENSIONS mm:** Length: 380 Width: 350 Height: 111

Code	No.	OE Reference Number	Engine Codes	Weight Kg
<b>3301769</b>	R15003000	Ford 303-1054, 303-1602, 303-1603, 303-1604, 303-1605, 303-1606, 303-1636, 303-732, 303-393A, 21-168		6.000

**R15003012**

## ENGINE TIMING TOOL SET, FORD

1.0 EcoBoost mHEV

- > Tool set for locking the intake and exhaust camshaft, flywheel, crankshaft and timing chain tensioner
- > Essential for correct valve timing adjustment when replacing timing chain or performing engine repairs
- > Includes removal and installation tool for the crankshaft seal ring



**DIMENSIONS mm:** Length: 470 Width: 330 Height: 100

Code	No.	OE Reference Number	Engine Codes	Weight Kg
<b>3301946</b>	R15003012	303-293, 303-1604, 303-1643, 303-1661, 303-1603, 303-1636, 303-732		4.800

**NEW**

**R15003009**

**ENGINE TIMING TOOL SET, FORD  
2.0 / 2.2 / 2.4 / 3.2 Duratorq**

- > Special tool kit for the professional adjustment of valve timing during timing chain replacement or engine overhaul
- > Includes the most essential special tools, such as for:
- > Locking the camshafts, crankshaft, and injection pump
- > Removing the crankshaft pulley and the injection pump gear
- > Centering the timing cover during assembly
- > Removing and installing the front crankshaft oil seal
- > Removing and installing the injection pump without removing the timing chain or altering the valve



**DIMENSIONS mm: Length: 470 Width: 330 Height: 100**

Code	No.	OE Reference Number	Engine Codes	Weight Kg
<b>3301943</b>	R15003009	303-249, 303-675, 303-679, 303-679A, 303-682, 303-698, 303-1151, 303-1317		3.200

**NEW**

**R15003008**

**ENGINE TIMING TOOL SET, FORD  
1.5 EcoBoost**

- > Special tool kit for the professional adjustment of valve timing during timing chain replacement or engine overhaul
- > Includes the most essential special tools, such as for:
- > Locking the intake and exhaust camshafts
- > Locking the crankshaft via the flywheel



**DIMENSIONS mm: Length: 290 Width: 210 Height: 70**

Code	No.	OE Reference Number	Engine Codes	Weight Kg
<b>3301942</b>	R15003008	303-1643, 303-1649		3.000

**HYUNDAI / KIA ENGINE TOOLS**

**R15303000**

**FLYWHEEL LOCKING TOOL, HYUNDAI / KIA**

- > Locking tool for professional locking of the crankshaft flywheel
- > Essential for changing the timing chain, or repairing the engine

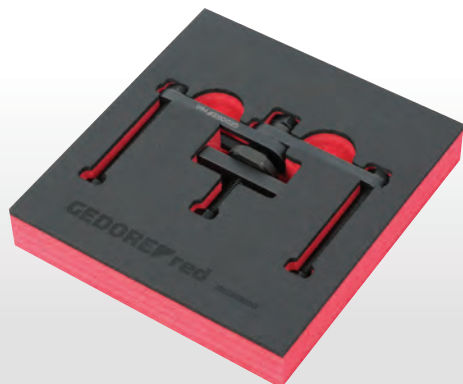

**DIMENSIONS mm: Length: 205 Width: 190 Height: 40**

Code	No.	OE Reference Number	Engine Codes	Weight Kg
<b>3301940</b>	R15303000	09231-2B100, 09231-3N100		0.600

**NEW**

**R15003025**

**ENGINE TIMING TOOL, HYUNDAI / KIA**

- > Tool set for locking flywheel, pre-tensioning the timing chain tensioner, and installing/removing the high-pressure pump
- > Essential for changing the timing chain, or repairing the engine



**DIMENSIONS mm: Length: 390 Width: 295 Height: 90**

Code	No.	OE Reference Number	Engine Codes	Weight Kg
<b>3301959</b>	R15003025	09321-2B100, 09331-2A000, 092313N100, 093312A010, 09331-1M100		2.000

# LIGHTING

*FINDING  
YOUR WAY*



## **DONT BE LEFT IN THE DARK**

- Lighting applications for all scenarios
- Precision Lighting for Precision Work

**NEW**

**R95500058**  
HEADLAMP 260

- > 4 light levels (50-260 lm)
- > Sturdy ABS housing
- > Charging time: 4 h; lighting time: up to 9 h
- > Gesture control for contactless switching on & off
- > Elastic headband, individually adjustable, easy take-off



Sensor	USB-C	4h	IK05	IP54	ABS	59x43x37 mm	52 g	2400 lux
5 W LED	260 lm	9 h	51 m	Li-Po	3.7 V   1200 mAh   4.44 Wh			

Code	No.	Luminous flux	Length mm	Width mm	Height mm	Weight Kg
3301762	R95500058	260	58	37	44	0,052

**NEW**

**R95700089**  
MINI WORK LAMP

- > Mobile companion for all applications
- > Extremely bright lamp in a small compact format
- > 2 Magnets provide different holding options in different work areas
- > Practical clip for attaching to a belt, shirt pocket or trouser pocket



26m	MAGNET	USB Type-C	IK07	IPX3
-----	--------	------------	------	------

Code	No.	Luminous flux	Length mm	Width mm	Height mm	Weight Kg
3301759	R95700089	300	89	21	12	0,090

**R95600320**  
INSPECTION LAMP

**NEW**

- > Ideal as a work lamp for mobile use in various areas
- > 5 switching functions for adjustable brightness
- > Magnet and 180° rotatable hook provide different holding options
- > Enables flexible and mobile use, as well as hands-free work

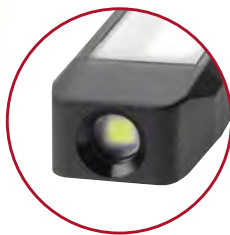

COB-LED + SMD-LED	22m	MAGNET	Micro-USB	HANGING HOOK	IK07	IP20
-------------------	-----	--------	-----------	--------------	------	------



Code	No.	Luminous flux	Length mm	Width mm	Height mm	Weight Kg
3301760	R95600320	500	320	33	43	0,260

**R95400145**  
SPOTLIGHT

**NEW**

- > Compact, portable spotlight
- > Ideal for working in places without power supply
- > Shockproof and splash-proof rubberized border
- > 180° rotatable stand



10W COB-LED	52m	Micro-USB	POWERBANK FUNCTION	IP65
-------------	-----	-----------	--------------------	------



Code	No.	Luminous flux	Length mm	Width mm	Height mm	Weight Kg
3301761	R95400145	1.400	145	40	145	0,453

**NEW**

R95700176

# CLAMP LAMP 1700

- > Extremely high brightness: Up to 1700 lumens, continuously adjustable in 4 modes
- > (Eco 100 lm, Low 300 lm, Medium 700 lm, High 1700 lm)
- > Very long runtime: Up to 24 hours operating time in Eco mode
- > Robust construction: IP65 and IK07 protection – dustproof, waterproof, and shockproof
- > Flexible design
- > Foldable (176.2 x 104.1 x 95.2 mm) and unfolded (205 x 104.1 x 174.8 mm)
- > 360° ball joint for flexible alignment
- > Practical mounting options: Clamp for attaching or standing, strong holding magnet for hands-free work
- > USB-C charging function: Includes USB Type-A to USB Type-C charging cable, approx. 5 hours charging time
- > Weight: 628 g – stable yet portable

**1700  
lumens****Extremely bright -  
adjustable****Extremely long operation  
in energy-saving mode****Various mounting options  
for hands-free work**

Code	No.	Luminous flux	Length mm	Width mm	Height mm	Weight Kg
3301925	R95700176	1.700	104,1	95,2	176,2	0,628

**NEW**

**R95600128**

# STICK LAMP 150

- > Moderate brightness: 150 lumens, ideal for targeted illumination of small work areas
- > Compact design – lightweight and handy
- > Switch functions: top LED (100 lm), main LED (150 lm), off – easy operation
- > Protection & robustness: IP54 & IK07 protection against dust and shock
- > Long runtime: Up to 3.5 hours of illumination
- > USB-C charging: Quick charge function, approx. 2.5 h charging time, incl. charging cable
- > Design: Matte finish with black on-off switch

**150 lumens**

**Highly portable and comfortable to hold**

**Flexible brightness selection as needed**

**Protection against dust and impact**

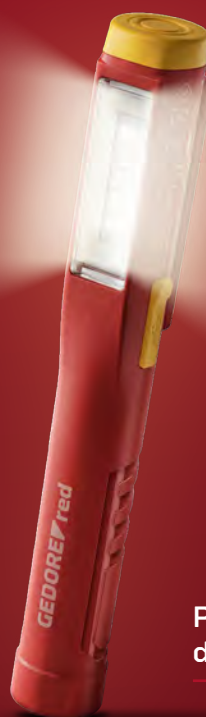

Code	No.	Luminous flux	Length mm	Width mm	Height mm	Weight Kg
3301924	R95600128	150	128,2	23,4	17,9	0,036

**R95300073**

# MINI- BOOST 1000

- > High brightness: Up to 1000 lumens in boost mode for extremely bright light
- > Long runtime: Up to 10 hours of light output in reduced modes
- > Versatile switch functions: 4 modes: 50% (250 lm), 100% (500 lm) Boost (1000 lm), Off – easy operation
- > Robust design: Aluminum housing with IP44 protection and IK07 shock resistance
- > Practical features: Strong holding magnet in the clip, USB-C charging port, charge control and remaining capacity display
- > Compact & lightweight: Dimensions: 22.5 x 21 x 73 mm, weight: 56 g – perfect for on the go
- > Scope of delivery: USB Type-C charging cable included

**1000 lumens**

**Versatile mounting and charging options plus indicator**

**Highly portable and discreet to carry**



**Long-lasting operation with lower consumption**

Code	No.	Luminous flux	Length mm	Width mm	Height mm	Weight Kg
3301926	R95300073	1.000	73	22,5	21	0,560

**NEW**

# INSTORE MERCHANDISERS

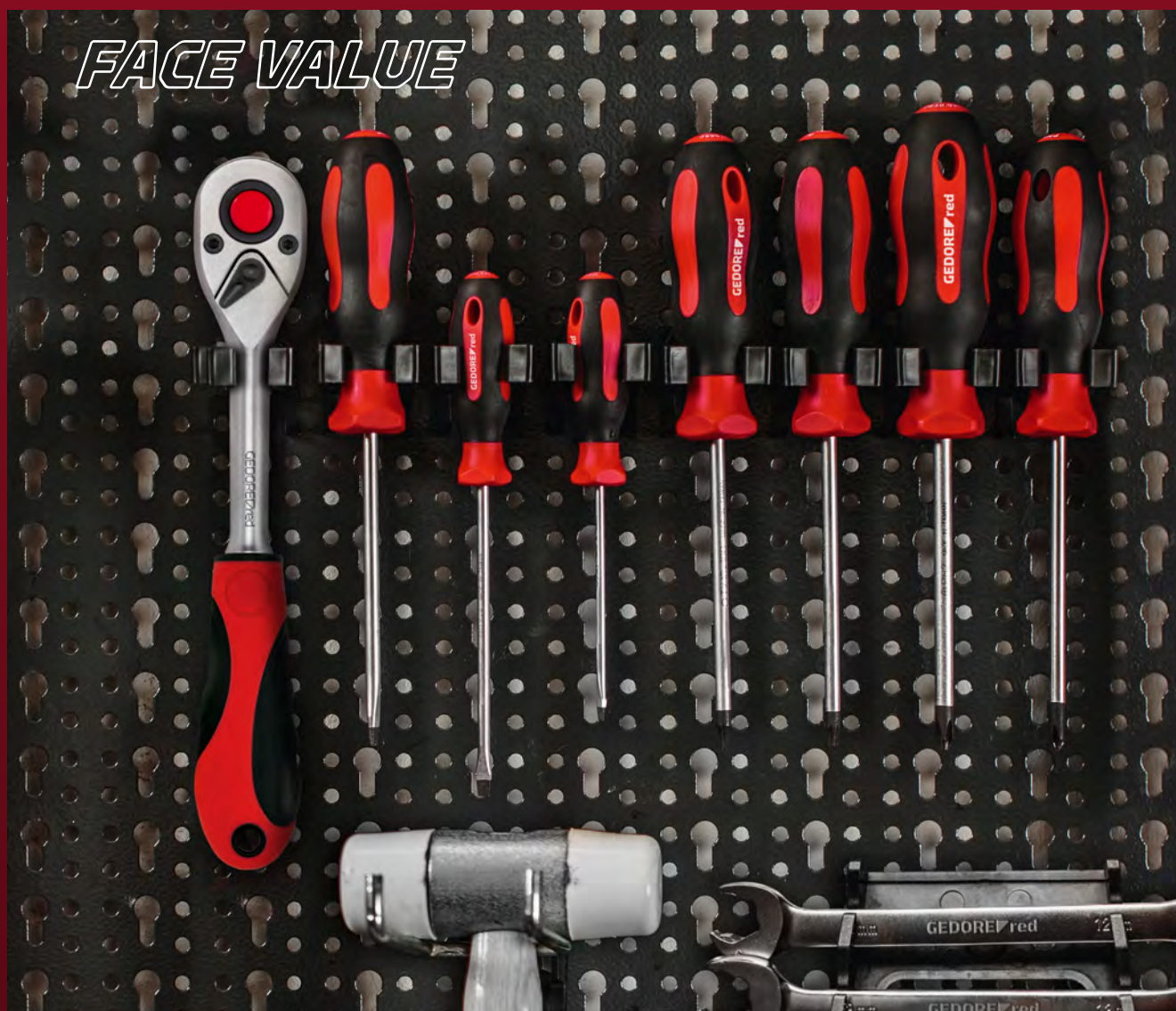

## **i**

### **INSTORE DISPLAY**

- The right tool display for every store
- Rigid sheetmetal structure with CNC cut hanging holes

**1-STAND**  
MERCHANDISING CONCEPT

- > Easy to assemble, rigid sheetmetal structure
- > Custom tool selection to fit your requirements
- > Black merchandiser with eye catching branding
- > Powder coated to prevent corrosion
- > Supplied with hanging hooks
- > Dimensions: W460 x H2040 x L950mm



DESCRIPTION	Code	DESCRIPTION	Code	DESCRIPTION	Code
R09100060	Comb spanner 6mm	3300962	R61101706	1/2 bi-hex. 17mm	3300332
R09100070	Comb spanner 7mm	3300963	R61101806	1/2 bi-hex. 18mm	3300333
R09100080	Comb spanner 8mm	3300964	R61101906	1/2 bi-hex. 19mm	3300334
R09100090	Comb spanner 9mm	3300965	R61102006	1/2 bi-hex. 20mm	3300335
R09100100	Comb spanner 10mm	3300966	R61102106	1/2 bi-hex. 21mm	3300336
R09100110	Comb spanner 11mm	3300967	R61102206	1/2 bi-hex. 22mm	3300337
R09100120	Comb spanner 12mm	3300968	R61021612	S/plug socket 16mm	3300401
R09100130	Comb spanner 13mm	3300969	R61022112	S/plug socket 20.8mm	3300402
R09100140	Comb spanner 14mm	3300970	R62550510	Bit socket 1/2 5mm	3300359
R09100150	Comb spanner 15mm	3300971	R62550610	Bit socket 1/2 6mm	3300360
R09100160	Comb spanner 16mm	3300972	R62550710	Bit socket 1/2 7mm	3300361
R09100170	Comb spanner 17mm	3300973	R62550810	Bit socket 1/2 8mm	3300362
R09100180	Comb spanner 18mm	3300974	R62550910	Bit socket 9mm	3300363
R09100190	Comb spanner 19mm	3300975	R62551010	Bit socket 10mm	3300364
R09100200	Comb spanner 20mm	3300976	R62551110	Bit socket 11mm	3300365
R09100210	Comb spanner 21mm	3300977	R62551210	Bit socket 12mm	3300366
R09100220	Comb spanner 22mm	3300978	R62551410	Bit socket 14mm	3300367
R09105017	Spanner set 17pcs	3300994	R62551710	Bit socket 17mm	3300368
R03100008	Adj.spanner w.25mm	3300997	R62551910	Bit socket 19mm	3300369
R03100010	Adj.spanner w.30mm	3300998	R62451310	Bit socket TX T20	3300391
R60000027	Revers.ratchet 1/2	3300410	R62451410	Bit socket TX T25	3300392
R61100806	1/2 bi-hex. 8mm	3300323	R62451510	Bit socket TX T27	3300393
R61100906	1/2 bi-hex. 9mm	3300324	R62451610	Bit socket TX T30	3300394
R61101006	1/2 bi-hex. 10mm	3300325	R62451810	Bit socket TX T40	3300395
R61101106	1/2 bi-hex. 11mm	3300326	R62451910	Bit socket TX T45	3300396
R61101206	1/2 bi-hex. 12mm	3300327	R62452110	Bit socket TX T50	3300397
R61101306	1/2 bi-hex. 13mm	3300328	R62452210	Bit socket TX T55	3300398
R61101406	1/2 bi-hex. 14mm	3300329	R62452310	Bit socket TX T60	3300399
R61101506	1/2 bi-hex. 15mm	3300330	R65200049	Sliding T-bar 300mm	3300408
R61101606	1/2 bi-hex. 16mm	3300331	R65100014	Socket ext. 75mm	3300403
R65100024	Socket ext. 125mm	3300404	R65100049	Socket ext. 250mm	3300406
R65300012	Universal joint 68mm	3300407	R49003016	Skt set 4-13mm 16pcs	3300050
R49003033	Skt set 4-13mm 33pcs	3300051	R49005023	Skt set 6-13mm 23pcs	3300026
R69013024	Skt set 10-32mm 24pcs	3300056	R46003100	Skt set 10-32mm 100pcs	3300063
R38002006	S/driver set PH+SL 6pcs	3301270	R36605009	Allen Key set 1.5-10mm	3301331
R28302200	Comb pliers 200mm	3301125	R28422200	Side cutter 200mm	3301128
R28502200	Teleph.pliers 200mm	3301133	R28100010	Water pump pliers	3301175
R27200010	Grip wrench	3301178	R92160005	Ball pein	3300769
R92420023	Claw hammer	3300782	R94550003	Tape measure 3m	3301427
R94550005	Tape measure 5m	3301428	R93210000	Prof.cutter knife	3301598
61200506	Socket 1/2 TX E8	3300348	61200706	Socket 1/2 TX E10	3300349
61200806	Socket 1/2 TX E11	3300350	61200906	Socket 1/2 TX E12	3300351
61201106	Socket 1/2 TX E14	3300352	61201306	Socket 1/2 TX E16	3300353
61201506	Socket 1/2 TX E18	3300354	61201706	Socket 1/2 TX E20	3300355
61201807	Socket 1/2 TX E22	3300356	61201907	Socket 1/2 TX E24	3300357

**2-STAND**  
MERCHANDISING CONCEPT

- > Easy to assemble, rigid sheetmetal structure
- > Custom tool selection to fit your requirements
- > Black merchandiser with eye catching branding
- > Powder coated to prevent corrosion
- > Supplied with hanging hooks
- > Dimensions: W460 x H2040 x L1900mm



DESCRIPTION	Code	DESCRIPTION	Code	DESCRIPTION	Code	DESCRIPTION	Code
R09100060 Comb spanner 6mm	3300962	R07100190 Ratchet spanner 19mm	3300839	R62551410 Bit socket 14mm	3300367	R92160002 Ball pein 1/4lbs	3300766
R09100070 Comb spanner 7mm	3300963	R07100200 Ratchet spanner 20mm	3300840	R62551710 Bitt socket 17mm	3300368	R92160005 Ball pein 1lbs	3300769
R09100080 Comb spanner 8mm	3300964	R07100210 Ratchet spanner 21mm	3300841	R62551910 Bit socket 19mm	3300369	R92160008 Ball pein 1.1/2lbs	3300770
R09100090 Comb spanner 9mm	3300965	R07100220 Ratchet spanner 22mm	3300842	R62451310 Bit socket TX T20	3300391	R92420023 Claw hammer	3300782
R09100100 Comb spanner 10mm	3300966	R07100240 Ratchet spanner 24mm	3300843	R62451410 Bit socket TX T25	3300392	R94550003 Tape measure 3m	3301427
R09100110 Comb spanner 11mm	3300967	R03100008 Adj.spanner w.25mm	3300997	R62451510 Bit socket TX T27	3300393	R94550005 Tape measure 5m	3301428
R09100120 Comb spanner 12mm	3300968	R03100010 Adj.spanner w.30mm	3300998	R62451610 Bit socket TX T30	3300394	R94420021 Digital calliper	3301430
R09100130 Comb spanner 13mm	3300969	R03100012 Adj.spanner w.36mm	3300999	R62451810 Bit socket TX T40	3300395	R93210000 Prof.cutter knife	3301598
R09100140 Comb spanner 14mm	3300970	R60000027 Revers.ratchet 1/2	3300410	R62451910 Bit socket TX T45	3300396	R93200025 Cutter knife	3301605
R09100150 Comb spanner 15mm	3300971	R61100806 1/2 bi-hex. 8mm	3300323	R62452110 Bit socket TX T50	3300397	R93250008 Pocket knife	3301615
R09100160 Comb spanner 16mm	3300972	R61100906 1/2 bi-hex. 9mm	3300324	R62452210 Bit socket TX T55	3300398	R99800000 Multifunction tool	3301757
R09100170 Comb spanner 17mm	3300973	R61101006 1/2 bi-hex. 10mm	3300325	R62452310 Bit socket TX T60	3300399	R93100052 Triangular file cut	3301591
R09100180 Comb spanner 18mm	3300974	R61101106 1/2 bi-hex. 11mm	3300326	R65200049 Sliding T-bar 300mm	3300408	R93120052 Flat file cut	3301592
R09100190 Comb spanner 19mm	3300975	R61101206 1/2 bi-hex. 12mm	3300327	R65100014 Socket ext. 75mm	3300403	R93140052 Round file cut	3301593
R09100200 Comb spanner 20mm	3300976	R61101306 1/2 bi-hex. 13mm	3300328	R65100024 Socket ext. 125mm	3300404	R93160052 Half-round file cut	3301594
R09100210 Comb spanner 21mm	3300977	R61101406 1/2 bi-hex. 14mm	3300329	R65100049 Socket ext. 250mm	3300406	R93180052 Square file cut	3301595
R09100220 Comb spanner 22mm	3300978	R61101506 1/2 bi-hex. 15mm	3300330	R65300012 Universal joint 68mm	3300407	R93000006 Key file set 6pcs	3301596
R09100230 Comb spanner 23mm	3300979	R61101606 1/2 bi-hex. 16mm	3300331	R49003016 Skt set 4-13mm 16pcs	3300050	R93600022 Mini pipe cutter	3301616
R09100240 Comb spanner 24mm	3300980	R61101706 1/2 bi-hex. 17mm	3300332	R49003033 Skt set 4-13mm 33pcs	3300051	R93400060 Scraper blade	3301754
R09100250 Comb spanner 25mm	3300981	R61101806 1/2 bi-hex. 18mm	3300333	R49005023 Skt set 1/4 6-13mm	3300026	R95300017 Torch light LED	3301755
R09100260 Comb spanner 26mm	3300982	R61101906 1/2 bi-hex. 19mm	3300334	R69013024 Skt set 1/2 10-32mm	3300056	61200506 Socket 1/2 TX E8	3300348
R09100270 Comb spanner 27mm	3300983	R61102006 1/2 bi-hex. 20mm	3300335	R46003100 Skt set 1/4+1/2	3300063	61200706 Socket 1/2 TX E10	3300349
R09100280 Comb spanner 28mm	3300984	R61102106 1/2 bi-hex. 21mm	3300336	R61208007 Skt set 1/2 TX 7pcs	3300028	61200806 Socket 1/2 TX E11	3300350
R09100290 Comb spanner 29mm	3300985	R61102206 1/2 bi-hex. 22mm	3300337	R62558110 S/driver bit sockets 1/2	3300027	61200906 Socket 1/2 TX E12	3300351
R09100300 Comb spanner 30mm	3300986	R61102306 1/2 bi-hex. 23mm	3300338	R62458107 S/driver bit sockets 1/2	3300029	61201106 Socket 1/2 TX E14	3300352
R09100320 Comb spanner 32mm	3300987	R61102406 1/2 bi-hex. 24mm	3300339	R69008012 Sockets+Ratchet 1/2	3300030	61201306 Socket 1/2 TX E16	3300353
R09105008 Spanner set 8pcs	3300988	R61102607 1/2 bi-hex. 26mm	3300341	R38002006 S/driver set PH+SL 6pcs	3301270	61201506 Socket 1/2 TX E18	3300354
R09105017 Spanner set 17pcs	3300994	R61102707 1/2 bi-hex. 27mm	3300342	R38920000 Ratchet screwdr. 13in1	3301337	61201706 Socket 1/2 TX E20	3300355
R09105012 Spanner set 12pcs	3300990	R61102807 1/2 bi-hex. 28mm	3300343	R36605009 Allen Key set 1.5-10mm	3301331	61201807 Socket 1/2 TX E22	3300356
R09105021 Spanner set 21pcs	3300991	R61103007 1/2 bi-hex. 30mm	3300345	R36675009 Allen Key set 1.5-10mm	3301335	61201907 Socket 1/2 TX E24	3300357
R07100080 Ratchet spanner 8mm	3300828	R61103207 1/2 bi-hex. 32mm	3300346	R28302200 Comb pliers 200mm	3301125		
R07100090 Ratchet spanner 9mm	3300829	R61021612 S/plug socket 16mm	3300401	R28422200 Side cutter 200mm	3301128		
R07100100 Ratchet spanner 10mm	3300830	R61022112 S/plug socket 20.8mm	3300402	R28502200 Teleph.pliers 200mm	3301133		
R07100110 Ratchet spanner 11mm	3300831	R62550510 Bit socket 1/2 5mm	3300359	R27160009 Pipe wrench 90° 9inch	3301204		
R07100120 Ratchet spanner 12mm	3300832	R62550610 Bit socket 1/2 6mm	3300360	R27160011 Pipe wrench 90° 11inch	3301205		
R07100130 Ratchet spanner 13mm	3300833	R62550710 Bit socket 1/2 7mm	3300361	R27160016 Pipe wrench 90° 16inch	3301207		
R07100140 Ratchet spanner 14mm	3300834	R62550810 Bit socket 1/2 8mm	3300362	R28100010 Water pump pliers	3301175		
R07100150 Ratchet spanner 15mm	3300835	R62550910 Bit socket 9mm	3300363	R27200010 Grip wrench 10inch	3301178		
R07100160 Ratchet spanner 16mm	3300836	R62551010 Bit socket 10mm	3300364	R92200050 Club hammer 1250g	3300726		
R07100170 Ratchet spanner 17mm	3300837	R62551110 Bit socket 11mm	3300365	R92200065 Club hammer 2000g	3300728		
R07100180 Ratchet spanner 18mm	3300838	R62551210 Bit socket 12mm	3300366	R92500058 Rubber mallet	3300739		

### 3-STAND MERCHANDISING CONCEPT

- > Easy to assemble, rigid sheetmetal structure
- > Custom tool selection to fit your requirements
- > Black merchandiser with eye catching branding
- > Powder coated to prevent corrosion
- > Supplied with hanging hooks
- > Dimensions: W460 x H2040 x L2850mm



DESCRIPTION	Code	DESCRIPTION	Code	DESCRIPTION	Code	DESCRIPTION	Code
R09100060 Comb spanner 6mm	3300962	R07100190 Ratchet spanner 19mm	3300839	R62551410 Bit socket 14mm	3300367	R92200050 Club hammer 1250g	3300726
R09100070 Comb spanner 7mm	3300963	R07100200 Ratchet spanner 20mm	3300840	R62551710 Bit socket 17mm	3300368	R92200065 Club hammer 2000g	3300728
R09100080 Comb spanner 8mm	3300964	R07100210 Ratchet spanner 21mm	3300841	R62551910 Bit socket 19mm	3300369	R92500058 Rubber mallet	3300739
R09100090 Comb spanner 9mm	3300965	R07100220 Ratchet spanner 22mm	3300842	R62451310 Bit socket TX T20	3300391	R92160002 Ball pein 1/4lbs	3300766
R09100100 Comb spanner 10mm	3300966	R07100240 Ratchet spanner 24mm	3300843	R62451410 Bit socket TX T25	3300392	R92160005 Ball pein 1lbs	3300769
R09100110 Comb spanner 11mm	3300967	R03100008 Adj.spanner w.25mm	3300997	R62451510 Bit socket TX T27	3300393	R92160008 Ball pein 1.1/2lbs	3300770
R09100120 Comb spanner 12mm	3300968	R03100010 Adj.spanner w.30mm	3300998	R62451610 Bit socket TX T30	3300394	R92420023 Claw hammer	3300782
R09100130 Comb spanner 13mm	3300969	R03100012 Adj.spanner w.36mm	3300999	R62451810 Bit socket TX T40	3300395	R94100051 Spirit level 300mm	3301422
R09100140 Comb spanner 14mm	3300970	R60000027 Revers.ratchet 1/2	3300410	R62451910 Bit socket TX T45	3300396	R94550005 Tape measure 3m	3301427
R09100150 Comb spanner 15mm	3300971	R61100806 1/2 bi-hex. 8mm	3300323	R62452110 Bit socket TX T50	3300397	R94550005 Tape measure 5m	3301428
R09100160 Comb spanner 16mm	3300972	R61100906 1/2 bi-hex. 9mm	3300324	R62452210 Bit socket TX T55	3300398	R94550008 Tape measure.8m	3301429
R09100170 Comb spanner 17mm	3300973	R61101006 1/2 bi-hex. 10mm	3300325	R62452310 Bit socket TX T60	3300399	R94420021 Digital calliper	3301430
R09100180 Comb spanner 18mm	3300974	R61101106 1/2 bi-hex. 11mm	3300326	R65200049 Sliding T-bar 300mm	3300408	R93210000 Prof.cutter knife	3301598
R09100190 Comb spanner 19mm	3300975	R61101206 1/2 bi-hex. 12mm	3300327	R65100014 Socket ext. 75mm	3300403	R93200010 Cutter knife 9mm	3301601
R09100200 Comb spanner 20mm	3300976	R61101306 1/2 bi-hex. 13mm	3300328	R65100024 Socket ext. 125mm	3300404	R93200025 Cutter knife	3301605
R09100210 Comb spanner 21mm	3300977	R61101406 1/2 bi-hex. 14mm	3300329	R65100049 Socket ext. 250mm	3300406	R93250008 Pocket knife	3301615
R09100220 Comb spanner 22mm	3300978	R61101506 1/2 bi-hex. 15mm	3300330	R65300012 Universal joint 68mm	3300407	R99800000 Multifunction tool	3301757
R09100230 Comb spanner 23mm	3300979	R61101606 1/2 bi-hex. 16mm	3300331	R49003016 Skt set 4-13mm 16pcs	3300050	R93350051 Multifunction saw	3301608
R09100240 Comb spanner 24mm	3300980	R61101706 1/2 bi-hex. 17mm	3300332	R49003016 Skt set 4-13mm 16pcs	3300050	R93100052 Triangular file cut	3301591
R09100250 Comb spanner 25mm	3300981	R61101806 1/2 bi-hex. 18mm	3300333	R49003016 Skt set 4-13mm 16pcs	3300050	R93120052 Flat file cut	3301592
R09100260 Comb spanner 26mm	3300982	R61101906 1/2 bi-hex. 19mm	3300334	R49005023 Skt set 1/4 6-13mm	3300026	R93140052 Round file cut	3301593
R09100270 Comb spanner 27mm	3300983	R61102006 1/2 bi-hex. 20mm	3300335	R69013024 Skt set 1/2 10-32mm	3300056	R93160052 Half-round file cut	3301594
R09100280 Comb spanner 28mm	3300984	R61102106 1/2 bi-hex. 21mm	3300336	R69013024 Skt set 1/2 10-32mm	3300056	R93180052 Square file cut	3301595
R09100290 Comb spanner 29mm	3300985	R61102206 1/2 bi-hex. 22mm	3300337	R46003100 Skt set 1/4+1/2	3300063	R93000006 Key file set 6pcs	3301596
R09100300 Comb spanner 30mm	3300986	R61102306 1/2 bi-hex. 23mm	3300338	R46003100 Skt set 1/4+1/2	3300063	R93600022 Mini pipe cutter	3301616
R09100320 Comb spanner 32mm	3300987	R61102406 1/2 bi-hex. 24mm	3300339	R61208007 Skt set 1/2 TX 7pcs	3300028	R93400060 Scraper blade	3301754
R09105008 Spanner set 8pcs	3300988	R61102607 1/2 bi-hex. 26mm	3300341	R62558110 S/driver bit sockets 1/2	3300027	R95300017 Torch light LED	3301755
R09105017 Spanner set 17pcs	3300994	R61102707 1/2 bi-hex. 27mm	3300342	R62458107 S/driver bit sockets 1/2	3300029	61200506 Socket 1/2 TX E8	3300348
R09105012 Spanner set 12pcs	3300990	R61102807 1/2 bi-hex. 28mm	3300343	R69008012 Sockets+Ratchet 1/2	3300030	61200706 Socket 1/2 TX E10	3300349
R09105021 Spanner set 21pcs	3300991	R61103007 1/2 bi-hex. 30mm	3300345	R38002006 S/driver set PH+SL 6pcs	3301270	61200806 Socket 1/2 TX E11	3300350
R07100080 Ratchet spanner 8mm	3300828	R61103207 1/2 bi-hex. 32mm	3300346	R38920000 Ratchet screwdr. 13in1	3301337	61200906 Socket 1/2 TX E12	3300351
R07100090 Ratchet spanner 9mm	3300829	R61021612 S/plug socket 16mm	3300401	R36605009 Allen Key set 1.5-10mm	3301331	61201106 Socket 1/2 TX E14	3300352
R07100100 Ratchet spanner 10mm	3300830	R61022112 S/plug socket 20.8mm	3300402	R36675009 Allen Key set 1.5-10mm	3301335	61201306 Socket 1/2 TX E16	3300353
R07100110 Ratchet spanner 11mm	3300831	R62550510 Bit socket 1/2 5mm	3300359	R28302200 Comb pliers 200mm	3301125	61201506 Socket 1/2 TX E18	3300354
R07100120 Ratchet spanner 12mm	3300832	R62550610 Bit socket 1/2 6mm	3300360	R28422200 Side cutter 200mm	3301128	61201706 Socket 1/2 TX E20	3300355
R07100130 Ratchet spanner 13mm	3300833	R62550710 Bit socket 1/2 7mm	3300361	R28502200 Teleph.pliers 200mm	3301133	61201807 Socket 1/2 TX E22	3300356
R07100140 Ratchet spanner 14mm	3300834	R62550810 Bit socket 1/2 8mm	3300362	R27160009 Pipe wrench 90° 9inch	3301204	61201907 Socket 1/2 TX E24	3300357
R07100150 Ratchet spanner 15mm	3300835	R62550910 Bit socket 9mm	3300363	R27160011 Pipe wrench 90° 11inch	3301205		
R07100160 Ratchet spanner 16mm	3300836	R62551010 Bit socket 10mm	3300364	R27160016 Pipe wrench 90° 16inch	3301207		
R07100170 Ratchet spanner 17mm	3300837	R62551110 Bit socket 11mm	3300365	R28100010 Water pump pliers	3301175		
R07100180 Ratchet spanner 18mm	3300838	R62551210 Bit socket 12mm	3300366	R27200010 Grip wrench 10inch	3301178		

<b>A</b>		<b>D</b>	
Adjustable Spanners...	15	Digital Measuring Caliper. ....	49
Allen Key Sockets 1/4". ....	18	Double Ring Spanners. ....	14
Allen Key Sockets 1/2". ....	23	Double Ring Spanner Sets. ....	14
Allen Key Socket Set 1/2", 10pc. ....	30	Double Open-Ended Spanners. ....	15
Allen Key Socket Set 1/2", 30pc. ....	32	Double Open-Ended Spanner Sets . ....	15
Allen Key Sets, 9pc. ....	39	Driving Handle 1/4". ....	20
		Drift Punch Set. ....	47
<b>B</b>		<b>E</b>	
Ball Pein Hammer, Hickory Handle. ....	47	Engine Tools - VAG ....	62-63
Ball Pein Hammer, Fibreglass Handle. ....	47	Engine Tools - BMW ....	64-65
Bike Set 1/4", 13pc. ....	33	Engine Tools - Ford ....	68-69
Bit Box 1/4", 32pc. ....	38	Engine Tools - Hyundai / Kia. ....	69
Bit Holder 1/4". ....	20	Engine Tools - Mercedes Benz ....	66-67
Bit Ratchet Set 1/4", 23pc. ....	28	Extensions 1/4". ....	19
		Extensions 3/8" ....	21
<b>C</b>		Extensions 1/2" ....	25
Cartridge Caulking Gun. ....	53	Extendable Shank Screwdriver 13 In 1 ....	38
Chisel & Punch Set, 6pc. ....	47		
Circlip Pliers External, Straight. ....	42	<b>F</b>	
Circlip Pliers External, Angled. ....	42	Female TX Sockets 1/4". ....	18
Circlip Pliers Internal, Straight. ....	43	Female TX Sockets 1/2. ....	23
Circlip Pliers Internal, Angled. ....	43	Female TX Socket Set 1/2", 7pc. ....	30
Circlip Pliers Set, 4pc. ....	43	Files. ....	52
Clamp Lamp 1700. ....	72	File Sets. ....	52
Claw Hammer, American Pattern. ....	47		
Club Hammer. ....	47	<b>G</b>	
Combination Ratchet Spanners . ....	13	Grip Wrench. ....	43
Combination Spanners . ....	13		
Combination Spanner Sets. ....	13	<b>H</b>	
Combination Ratchet Spanner Sets. ....	14	Hacksaws. ....	52
Combination Pliers. ....	41	Half-Moon Ring Spanners. ....	15
Combination Plier Set. ....	41	Hand Riveter. ....	45
Cranked Socket Key Set ....	38	Head Lamp 260. ....	71
Crimping Pliers ....	44		

Heavy-Duty Utility Knife. . . . . 51

Hose Clamp Pliers Set, 3pc. . . . . 59

Hook Set, 4pc. . . . . 59

**I**

Ideal Pattern Snips. . . . . 51

Impact Socket Sets . . . . . 32, 33

Inspection Lamp . . . . . 71

**K**

Key File Set. . . . . 52

**L**

LED Torch. . . . . 53

**M**

Magnetic Lifter. . . . . 60

Magnetic Tray. . . . . 60

Male TX Sockets 1/4". . . . . 18

Male TX Sockets 1/2". . . . . 25

Male TX Socket Set 1/2", 7pc. . . . . 30

Merchandiser Concepts. . . . . 74-77

Mini Boost 1000 . . . . . 73

Mini Work Lamp . . . . . 71

Multifunction Tool. . . . . 53

Multi Side Cutter. . . . . 42

**O**

Oil Filter Spanner . . . . . 59

Oil Filter Strap Wrench. . . . . 59

**P**

Pin Punch Set. . . . . 47

Pipe Wrench-Swedish Pattern. . . . . 44

Pipe Wrench-American Pattern. . . . . 44

Plastic Staple Remover . . . . . 61

Pliers Set . . . . . 41

Pocket Knife . . . . . 51

Power Side Cutter. . . . . 41

**Q**

Quick-Change Bit Holder 1/4". . . . . 20

**R**

Ratchet Handle With Coupler 1/2" . . . . . 22

Reversible Ratchet 1/4" . . . . . 17

Reversible Ratchets 3/8". . . . . 21

Reversible Ratchet 1/2" . . . . . 22

Riveter. . . . . 45

**S**

Safety Knife. . . . . 51

Service Trolley. . . . . 11

Scraper. . . . . 53

Screwdriver Sets. . . . . 37, 38

Side Cutter . . . . . 41

Side Cutter, Multi. . . . . 42

Sliding T-Bar with Slider 1/4". . . . . 19

Sliding T-Bar with Slider 3/8". . . . . 21

Sliding T-Bar with Slider 1/2". . . . . 25

Small Tube Cutter. . . . . 53

Sockets 1/4". . . . . 18

Socket Extensions 1/4". . . . . 19

Socket Holder 1/4". . . . . 20

Sockets, hex 3/8". . . . . 21

Socket Extensions 3/8". . . . . 21

Sockets 1/2". . . . . 23, 24

Socket Extensions 1/2". . . . . 25

Socket Sets 1/4". . . . . 27, 28

Socket Sets 3/8". . . . . 28

Socket Sets 1/2". . . . .	28, 30, 32, 33	Utility Knife, 9mm. . . . .	51
Socket Sets 1/4" + 1/2" . . . . .	29, 30	Universal Tool Assortment 1/2", 65pc. . . . .	3
Socket Set 1/4" + 3/8" + 1/2". . . . .	31		
Spark Plug Sockets 1/2". . . . .	24	<b>V</b>	
Spotlight. . . . .	71	VDE Cable Knife. . . . .	57
Square Drive Adapter Set, 4pc. . . . .	14	VDE Combination Pliers. . . . .	55
Stick Lamp 150 . . . . .	73	VDEI Interchangeable Blade Set. . . . .	56
Swivel-Head Telescopic Ratchet 1/2". . . . .	22	VDE Power Side Cutter. . . . .	55
		VDE Set, 5pc. . . . .	57
<b>T</b>		VDE Telephone Pliers. . . . .	55
Tape Measures . . . . .	49	Vice . . . . .	53
Telephone Pliers . . . . .	41		
Tool Assortment 1/2", 62pc. . . . .	3	<b>W</b>	
Tool Assortment 1/2", 65pc. . . . .	3	Water Pump Pliers. . . . .	45
Tool Assortment, 95pc. . . . .	6	Wheel Spanner. . . . .	60
Tool Assortment, 114pc. . . . .	4	Workshop Toolkit 1/4" + 3/8" + 1/2", 218pc . . . . .	7
Tool Assortment 1/4" + 1/2", 113pc. . . . .	5	Workshop Trolley, Mechanics . . . . .	11
Tool Assortment 1/4" + 3/8" + 1/2", 218pc. . . . .	7		
Tool Assortment , 119pc. . . . .	8		
Tool Panel Starter Kit, 19pc . . . . .	9		
Toolbox. . . . .	11		
Tool Chest. . . . .	11		
Tool Trolley, Mechanic. . . . .	11		
Tool Set T-Handle			
With Ratchet 1/4", 37pc. . . . .	27		
Torque Wrenches. . . . .	35		
T-Handle Socket Key Set, 6pc. . . . .	38		
Tower Pincer. . . . .	43		
Tube Cutter. . . . .	53		
<b>U</b>			
Universal Joint 1/4". . . . .	19		
Universal Joint 1/2". . . . .	25		



Brands of the GEDORE Group: GEDORE | GEDORE red | Ochsenkopf

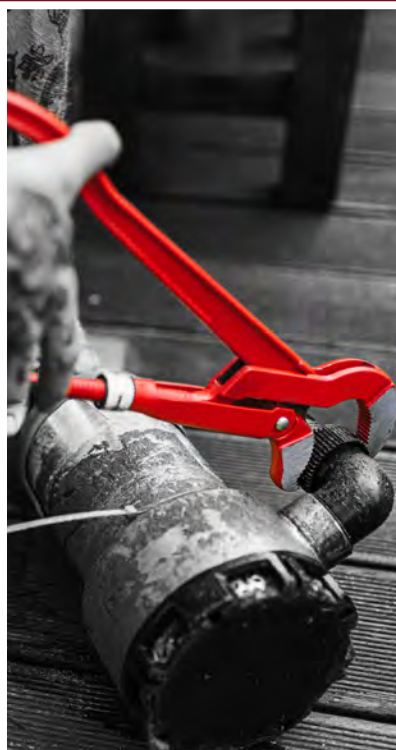

## **YOUR WORLD** OUR TOOLS

### HEAD OFFICE & FACTORY

#### Durban

103 Qashana Khuzwayo Road, New Germany, 3610  
PO Box 68, New Germany, 3620  
Tel: +27 (0)31 705-3587  
Fax: +27 (0)31 705-3277

Email: [sales@gedore.co.za](mailto:sales@gedore.co.za) /  
[exports@gedore.co.za](mailto:exports@gedore.co.za)  
Website: [www.gedore.co.za](http://www.gedore.co.za)

### SALES OFFICE

#### Johannesburg

26 Village Crescent, Linbro Business Park  
PO Box 72, Linbro Park, 2065  
Tel: +27 (0)11 608-5959  
Fax: +27 (0)11 608-2953



[www.facebook.com/gedoretoolssouthafrica](https://www.facebook.com/gedoretoolssouthafrica)